

WELCOME

Welcome to on-line help. Use this on-line manual for assistance in normal operation of your LeCroy oscilloscope. You can also use it for help with LeCroy software options that you may have purchased.

Use the Table of Contents or Index at left to find information.



HOW TO USE ON-LINE HELP

Type Styles

Activators of pop-up text and images appear as green, underlined, italic: *Pop-up*. To close pop-up text and images after opening them, touch the pop-up text again.

Link text appears blue and underlined: [Link](#). Links jump you to other topics, URLs, or images; or to another location within the same Help window. After making a jump, you can touch the [Back](#) icon in the toolbar at the top of the Help window to return to the Help screen you just left. With each touch of the **Back** icon, you return to the preceding Help screen.



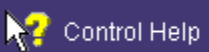

Instrument Help

When you press the front panel **HELP** button  (if available), or touch the on-screen **Help** button , you will be presented with a menu: you can choose either to have information found for you automatically or to search for information yourself.

If you want context-sensitive Help, that is, Help related to what was displayed on the screen when you requested Help, touch

 in the drop-down menu, then touch the on-screen control (or front panel button or knob) that you need information about. The instrument will automatically display Help about that control.

If you want information about something not displayed on the screen, touch one of the buttons inside the drop-down menu to display the on-line Help manual:

	Contents displays the Table of Contents.
	Index displays an alphabetical listing of keywords.
	Search locates every occurrence of the keyword that you enter.
	www.LeCroy.com connects you to LeCroy's Web site where you can find Lab Briefs, Application Notes, and other useful information. This feature requires that the instrument be connected to the internet through the Ethernet port on the scope's rear panel. Refer to Remote Communication for setup instructions.
	About opens the Utilities "Status" dialog, which shows software version and other system information.

Once opened, the Help window will display its navigation pane: the part of the window that shows the Table of Contents and Index. When you touch anywhere outside of the Help window, this navigation pane will disappear to reveal more of your signal. To make it return, touch the [Show](#) icon at the top of the Help window or touch inside the Help information pane.

Windows Help

In addition to instrument Help, you can also access on-line Help for Microsoft® Windows®. This help is accessible by minimizing the scope application, then touching the **Start** button in the Windows task bar at the bottom of the screen and selecting **Help**.

[Top of Page](#)

RETURNING A PRODUCT FOR SERVICE OR REPAIR

If you need to return a LeCroy product, identify it by its model and serial numbers. Describe the defect or failure, and give us your name and telephone number.

For factory returns, use a Return Authorization Number (RAN), which you can get from customer service. Write the number clearly on the outside of the shipping carton.

Return products requiring only maintenance to your local customer service center.

If you need to return your scope for any reason, use the original shipping carton. If this is not possible, be sure to use a rigid carton. The scope should be packed so that it is surrounded by a minimum of four inches (10 cm) of shock absorbent material.

Within the warranty period, transportation charges to the factory will be your responsibility. Products under warranty will be returned to you with transport prepaid by LeCroy. Outside the warranty period, you will have to provide us with a purchase order number before the work can be done. You will be billed for parts and labor related to the repair work, as well as for shipping.

You should prepay return shipments. LeCroy cannot accept COD (Cash On Delivery) or Collect Return shipments. We recommend using air freight.

[Top of Page](#)

TECHNICAL SUPPORT

You can get assistance with installation, calibration, and a full range of software applications from your customer service center. Visit the LeCroy Web site at <http://www.lecroy.com> for the center nearest you.

STAYING UP-TO-DATE

To maintain your instrument's performance within specifications, have us calibrate it at least once a year. LeCroy offers state-of-the-art performance by continually refining and improving the instrument's capabilities and operation. We frequently update both firmware and software during service, free of charge during warranty.

You can also install new purchased software options in your scope yourself, without having to return it to the factory. Simply provide us with your instrument serial number and ID, and the version number of instrument software installed. We will provide you with a unique option key that consists of a code to be entered through the Utilities' Options dialog to load the software option.

[Top of Page](#)

WARRANTY

The instrument is warranted for normal use and operation, within specifications, for a period of three years from shipment. LeCroy will either repair or, at our option, replace any product returned to one of our authorized service centers within this period. However, in order to do this we must first examine the product and find that it is defective due to workmanship or materials and not due to misuse, neglect, accident, or abnormal conditions or operation.

LeCroy shall not be responsible for any damage caused by improper connection to incompatible equipment, or for any damage or malfunction caused by the use of non-LeCroy supplies.

Spare and replacement parts, and repairs, all have a 90-day warranty.

The oscilloscope's firmware has been thoroughly tested and is presumed to be functional. Nevertheless, it is supplied without warranty of any kind covering detailed performance. Products not made by LeCroy are covered solely by the warranty of the original equipment manufacturer.

[Top of Page](#)

COPYRIGHT

© 2004 by LeCroy Corporation. All rights reserved.

LeCroy, ActiveDSO, ProBus, SMART Trigger, JitterTrack, WavePro, and Waverunner are registered trademarks of LeCroy Corporation. WaveMaster and X-Stream are trademarks of LeCroy Corporation. Information in this publication supersedes all earlier versions. Specifications subject to change without notice.

LeCroy Corporation
700 Chestnut Ridge Road
Chestnut Ridge, NY 10977-6499

Tel: (845) 578 6020
Fax: (845) 578 5985

Internet: www.lecroy.com



**ISO
9001:2000
FM 65813**

Manufactured under an ISO 9000 Registered Quality Management System

Windows License Agreement

LeCroy's agreement with Microsoft prohibits users from running software on LeCroy X-Stream oscilloscopes that is not relevant to measuring, analyzing, or documenting waveforms.

END-USER LICENSE AGREEMENT FOR LECROY® X-STREAM™ SOFTWARE

IMPORTANT-READ CAREFULLY: THIS END-USER LICENSE AGREEMENT (“EULA”) IS A LEGAL AGREEMENT BETWEEN THE INDIVIDUAL OR ENTITY LICENSING THE SOFTWARE PRODUCT (“YOU” OR “YOUR”) AND LECROY CORPORATION (“LECROY”) FOR THE SOFTWARE PRODUCT(S) ACCOMPANYING THIS EULA, WHICH INCLUDE(S): COMPUTER PROGRAMS; ANY “ONLINE” OR ELECTRONIC DOCUMENTATION AND PRINTED MATERIALS PROVIDED BY LECROY HERewith (“DOCUMENTATION”); ASSOCIATED MEDIA; AND ANY UPDATES (AS DEFINED BELOW) (COLLECTIVELY, THE “SOFTWARE PRODUCT”). BY USING AN INSTRUMENT TOGETHER WITH OR CONTAINING THE SOFTWARE PRODUCT, OR BY INSTALLING, COPYING, OR OTHERWISE USING THE SOFTWARE PRODUCT, IN WHOLE OR IN PART, YOU AGREE TO BE BOUND BY THE TERMS OF THIS EULA. IF YOU DO NOT AGREE TO THE TERMS OF THIS EULA, DO NOT INSTALL, COPY, OR OTHERWISE USE THE SOFTWARE PRODUCT; YOU MAY RETURN THE SOFTWARE PRODUCT TO YOUR PLACE OF PURCHASE FOR A FULL REFUND. IN ADDITION, BY INSTALLING, COPYING, OR OTHERWISE USING ANY MODIFICATIONS, ENHANCEMENTS, NEW VERSIONS, BUG FIXES, OR OTHER COMPONENTS OF THE SOFTWARE PRODUCT THAT LECROY PROVIDES TO YOU SEPARATELY AS PART OF THE SOFTWARE PRODUCT (“UPDATES”), YOU AGREE TO BE BOUND BY ANY ADDITIONAL LICENSE TERMS THAT ACCOMPANY SUCH UPDATES. IF YOU DO NOT AGREE TO SUCH ADDITIONAL LICENSE TERMS, YOU MAY NOT INSTALL, COPY, OR OTHERWISE USE SUCH UPDATES.

THE PARTIES CONFIRM THAT THIS AGREEMENT AND ALL RELATED DOCUMENTATION ARE AND WILL BE DRAFTED IN ENGLISH. LES PARTIES AUX PRÉSENTÉS CONFIRMENT LEUR VOLONTÉ QUE CETTE CONVENTION DE MÊME QUE TOUS LES DOCUMENTS Y COMPRIS TOUT AVIS QUI S'Y RATTACHÉ, SOIENT REDIGÉS EN LANGUE ANGLAISE.

1. GRANT OF LICENSE.

1.1 License Grant. Subject to the terms and conditions of this EULA and payment of all applicable fees, LeCroy grants to you a nonexclusive, nontransferable license (the “License”) to: (a) operate the Software Product as provided or installed, in object code form, for your own internal business purposes, (i) for use in or with an instrument provided or manufactured by LeCroy (an “Instrument”), (ii) for testing your software product(s) (to be used solely by you) that are designed to operate in conjunction with an Instrument (“Your Software”), and (iii) make one copy for archival and back-up purposes; (b) make and use copies of the Documentation; provided that such copies will be used only in connection with your licensed use of the Software Product, and such copies may not be republished or distributed (either in hard copy or electronic form) to any third party; and (c) copy, modify, enhance and prepare derivative works (“Derivatives”) of the source code version of those portions of the Software Product set forth in and identified in the Documentation as “Samples” (“Sample Code”) for the sole purposes of designing, developing, and testing Your Software. If you are an entity, only one designated individual within your organization, as designated by you, may exercise the License; provided that additional individuals within your organization may assist with respect to reproducing and distributing Sample Code as permitted under Section 1.1(c)(ii). LeCroy reserves all rights not expressly granted to you. No license is granted hereunder for any use other than that specified herein, and no license is granted for any use in combination or in connection with other products or services (other than Instruments and Your Software) without the express prior written consent of LeCroy. The Software Product is licensed as a single product. Its component parts may not be separated for use by more than one user. This EULA does not grant you any rights in connection with any trademarks or service marks of LeCroy. The Software Product is protected by copyright laws and international copyright treaties, as well as other intellectual property laws and treaties. The Software Product is licensed, not sold. The terms of this printed, paper EULA supersede the terms of any on-screen license agreement found within the Software Product.

1.2 Upgrades. If the Software Product is labeled as an “upgrade,” (or other similar designation) the License will not take effect, and you will have no right to use or access the Software Product unless you are properly licensed to use a product identified by LeCroy as being eligible

for the upgrade ("Underlying Product"). A Software Product labeled as an "upgrade" replaces and/or supplements the Underlying Product.

You may use the resulting upgraded product only in accordance with the terms of this EULA. If the Software Product is an upgrade of a component of a package of software programs that you licensed as a single product, the Software Product may be used and transferred only as part of that single product package and may not be separated for use on more than one computer.

1.3. Limitations. Except as specifically permitted in this EULA, you will not directly or indirectly (a) use any Confidential Information to create any software or documentation that is similar to any of the Software Product or Documentation; (b) encumber, transfer, rent, lease, time-share or use the Software Product in any service bureau arrangement; (c) copy (except for archival purposes), distribute, manufacture, adapt, create derivative works of, translate, localize, port or otherwise modify the Software Product or the Documentation; (d) permit access to the Software Product by any party developing, marketing or planning to develop or market any product having functionality similar to or competitive with the Software Product; (e) publish benchmark results relating to the Software Product, nor disclose Software Product features, errors or bugs to third parties; or (f) permit any third party to engage in any of the acts proscribed in clauses (a) through (e). In jurisdictions in which transfer is permitted, notwithstanding the foregoing prohibition, transfers will only be effective if you transfer a copy of this EULA, as well as all copies of the Software Product, whereupon your right to use the Software product will terminate. Except as described in this Section 1.3, You are not permitted (i) to decompile, disassemble, reverse compile, reverse assemble, reverse translate or otherwise reverse engineer the Software Product, (ii) to use any similar means to discover the source code of the Software Product or to discover the trade secrets in the Software Product, or (iii) to otherwise circumvent any technological measure that controls access to the Software Product. You may reverse engineer or otherwise circumvent the technological measures protecting the Software Product for the sole purpose of identifying and analyzing those elements that are necessary to achieve Interoperability (the "Permitted Objective") only if: (A) doing so is necessary to achieve the Permitted Objective and it does not constitute infringement under Title 17 of the United States Code; (B) such circumvention is confined to those parts of the Software Product and to such acts as are necessary to achieve the Permitted Objective; (C) the information to be gained thereby has not already been made readily available to you or has not been provided by LeCroy within a reasonable time after a written request by you to LeCroy to provide such information; (D) the information gained is not used for any purpose other than the Permitted Objective and is not disclosed to any other person except as may be necessary to achieve the Permitted Objective; and (E) the information obtained is not used (1) to create a computer program substantially similar in its expression to the Software Product including, but not limited to, expressions of the Software Product in other computer languages, or (2) for any other act restricted by LeCroy's intellectual property rights in the Software Product. "Interoperability" will have the same meaning in this EULA as defined in the Digital Millennium Copyright Act, 17 U.S.C. §1201(f), the ability of computer programs to exchange information and of such programs mutually to use the information which has been exchanged.

1.4 PRERELEASE CODE. Portions of the Software Product may be identified as prerelease code ("Prerelease Code"). Prerelease Code is not at the level of performance and compatibility of the final, generally available product offering. The Prerelease Code may not operate correctly and may be substantially modified prior to first commercial shipment. LeCroy is not obligated to make this or any later version of the Prerelease Code commercially available. The License with respect to the Prerelease Code terminates upon availability of a commercial release of the Prerelease Code from LeCroy.

2. SUPPORT SERVICES. At LeCroy's sole discretion, from time to time, LeCroy may provide Updates to the Software Product. LeCroy shall have no obligation to revise or update the Software Product or to support any version of the Software Product. At LeCroy's sole discretion, upon your request, LeCroy may provide you with support services related to the Software Product ("Support Services") pursuant to the LeCroy policies and programs described in the Documentation or otherwise then in effect, and such Support Services will be subject to LeCroy's then-current fees therefor, if any. Any Update or other supplemental software code provided to you pursuant to the Support Services will be considered part of the Software Product and will be subject to the terms and conditions of this EULA. LeCroy may use any technical information you provide to LeCroy during LeCroy's provision of Support Services, for LeCroy's business purposes, including for product support and development. LeCroy will not utilize such technical information in a form that personally identifies you.

3. PROPRIETARY RIGHTS.

3.1 Right and Title. All right, title and interest in and to the Software Product and Documentation (including but not limited to any intellectual property or other proprietary rights, images, icons, photographs, text, and "applets" embodied in or incorporated into the Software Product, collectively, "Content"), and all Derivatives, and any copies thereof are owned by LeCroy and/or its licensors or third-party suppliers, and is protected by applicable copyright or other intellectual property laws and treaties. You will not take any action inconsistent with such title and ownership. This EULA grants you no rights to use such Content outside of the proper exercise of the license granted hereunder, and LeCroy will not be responsible or liable therefor.

3.2 Intellectual Property Protection. You may not alter or remove any printed or on-screen copyright, trade secret, proprietary or other legal notices contained on or in copies of the Software Product or Documentation.

3.3 Confidentiality. Except for the specific rights granted by this EULA, neither party shall use or disclose any Confidential Information (as defined below) of the other party without the written consent of the disclosing party. A party receiving Confidential Information from the other shall use the highest commercially reasonable degree of care to protect the Confidential Information, including ensuring that its employees and consultants with access to such Confidential Information have agreed in writing not to disclose the Confidential Information. You shall bear the responsibility for any breaches of confidentiality by your employees and consultants. Within ten (10) days after request of the disclosing party, and in the disclosing party's sole discretion, the receiving party shall either return to the disclosing party originals and copies of any Confidential Information and all information, records and materials developed therefrom by the receiving party, or destroy the same, other than such Confidential Information as to which this EULA expressly provides a continuing right to the receiving party to retain at the time of the request. Either party may only disclose the general nature, but not the specific financial terms, of this EULA without the prior consent of the other party; provided either party may provide a copy of this EULA to any finance provider in conjunction with a financing transaction, if such provider agrees to keep this EULA confidential. Nothing herein shall prevent a receiving party from disclosing all or part of the Confidential Information as necessary pursuant to the lawful requirement of a governmental agency or when disclosure is required by operation of law; provided that prior to any such disclosure, the receiving party shall use reasonable efforts to (a) promptly notify the disclosing party in writing of such requirement to disclose, and (b) cooperate fully with the disclosing party in protecting against any such disclosure or obtaining a protective order. Money damages will not be an adequate remedy if this Section 4.3 is breached and, therefore, either party shall, in addition to any other legal or equitable remedies, be entitled to seek an injunction or similar equitable relief against such breach or threatened breach without the necessity of posting any bond. As used herein, "Confidential Information" means LeCroy pricing or information concerning new LeCroy products, trade secrets (including without limitation all internal header information contained in or created by the Software Product, all benchmark and performance test results and all Documentation) and other proprietary information of LeCroy; and any business, marketing or technical information disclosed by LeCroy, or its representatives, or you in relation to this EULA, and either (i) disclosed in writing and marked as confidential at the time of disclosure or (ii) disclosed in any other manner such that a reasonable person would understand the nature and confidentiality of the information. Confidential Information does not include information (A) already in the possession of the receiving party without an obligation of confidentiality to the disclosing party, (B) hereafter rightfully furnished to the receiving

party by a third party without a breach of any separate nondisclosure obligation to the disclosing party, (C) publicly known without breach of this EULA, (d) furnished by the disclosing party to a third party without restriction on subsequent disclosure, or (e) independently developed by the receiving party without reference to or reliance on the Confidential Information.

4. TERMINATION. This EULA will remain in force until termination pursuant to the terms hereof. You may terminate this EULA at any time. This EULA will also terminate if you breach any of the terms or conditions of this EULA. You agree that if this EULA terminates for any reason, the License will immediately terminate and you will destroy all copies of the Software Product (and all Derivatives), installed or otherwise, the Documentation, and the Confidential Information (and all derivatives of any of the foregoing) that are in your possession or under your control. The provisions of Sections 1.3, 4, 6, 7, 8, and 9 will survive any termination or expiration hereof.

5. U.S. GOVERNMENT RESTRICTED RIGHTS. If any Software Product or Documentation is acquired by or on behalf of a unit or agency of the United States Government (any such unit or agency, the "Government"), the Government agrees that the Software Product or Documentation is "commercial computer software" or "commercial computer software documentation" and that, absent a written agreement to the contrary, the Government's rights with respect to the Software Product or Documentation are, in the case of civilian agency use, Restricted Rights, as defined in FAR §52.227.19, and if for Department of Defense use, limited by the terms of this EULA, pursuant to DFARS §227.7202. The use of the Software Product or Documentation by the Government constitutes acknowledgment of LeCroy's proprietary rights in the Software Product and Documentation. Manufacturer is LeCroy Corporation, 700 Chestnut Ridge Road, Chestnut Ridge, NY 10977 USA.

6. EXPORT RESTRICTIONS. You agree that you will not export or re-export the Software Product, any part thereof, or any process or service that is the direct product of the Software Product (the foregoing collectively referred to as the "Restricted Components"), to any country, person, entity or end user subject to U.S. export restrictions. You specifically agree not to export or re-export any of the Restricted Components (a) to any country to which the U.S. has embargoed or restricted the export of goods or services, which currently include, but are not necessarily limited to Cuba, Iran, Iraq, Libya, North Korea, Sudan and Syria, or to any national of any such country, wherever located, who intends to transmit or transport the Restricted Components back to such country; (b) to any end user who you know or have reason to know will utilize the Restricted Components in the design, development or production of nuclear, chemical or biological weapons; or (c) to any end-user who has been prohibited from participating in U.S. export transactions by any federal agency of the U.S. government. You warrant and represent that neither the BXA nor any other U.S. federal agency has suspended, revoked or denied your export privileges. It is your responsibility to comply with the latest United States export regulations, and you will defend and indemnify LeCroy from and against any damages, fines, penalties, assessments, liabilities, costs and expenses (including reasonable attorneys' fees and court costs) arising out of any claim that the Software Product, Documentation, or other information or materials provided by LeCroy hereunder were exported or otherwise accessed, shipped or transported in violation of applicable laws and regulations.

7. RISK ALLOCATION.

7.1 No Warranty. THE SOFTWARE PRODUCT IS NOT ERROR-FREE AND THE SOFTWARE PRODUCT AND SUPPORT SERVICES IS/ARE BEING PROVIDED "AS IS" WITHOUT WARRANTY OF ANY KIND. LECROY, FOR ITSELF AND ITS SUPPLIERS, HEREBY DISCLAIMS ALL WARRANTIES, WHETHER EXPRESS OR IMPLIED, ORAL OR WRITTEN, WITH RESPECT TO THE SOFTWARE PRODUCT OR ANY SUPPORT SERVICES INCLUDING, WITHOUT LIMITATION, ALL IMPLIED WARRANTIES OF TITLE OR NON-INFRINGEMENT, MERCHANTABILITY, FITNESS FOR A PARTICULAR PURPOSE, ACCURACY, INTEGRATION, VALIDITY, EXCLUSIVITY, MERCHANTABILITY, NON-INTERFERENCE WITH ENJOYMENT, FITNESS FOR ANY PARTICULAR PURPOSE, AND ALL WARRANTIES IMPLIED FROM ANY COURSE OF DEALING OR USAGE OF TRADE. YOU ACKNOWLEDGE THAT NO WARRANTIES HAVE BEEN MADE TO YOU BY OR ON BEHALF OF LECROY OR OTHERWISE FORM THE BASIS FOR THE BARGAIN BETWEEN THE PARTIES.

7.2 Limitation of Liability. LECROY'S LIABILITY FOR DAMAGES FOR ANY CAUSE WHATSOEVER, REGARDLESS OF THE FORM OF ANY CLAIM OR ACTION, SHALL NOT EXCEED THE GREATER OF THE AMOUNT ACTUALLY PAID BY YOU FOR THE SOFTWARE PRODUCT OR U.S.\$5.00; PROVIDED THAT IF YOU HAVE ENTERED INTO A SUPPORT SERVICES AGREEMENT WITH LECROY, LECROY'S ENTIRE LIABILITY REGARDING SUPPORT SERVICES WILL BE GOVERNED BY THE TERMS OF THAT AGREEMENT. LECROY SHALL NOT BE LIABLE FOR ANY LOSS OF PROFITS, LOSS OF USE, LOSS OF DATA, INTERRUPTION OF BUSINESS, NOR FOR INDIRECT, SPECIAL, INCIDENTAL, CONSEQUENTIAL OR EXEMPLARY DAMAGES OF ANY KIND, WHETHER UNDER THIS EULA OR OTHERWISE ARISING IN ANY WAY IN CONNECTION WITH THE SOFTWARE PRODUCT, THE DOCUMENTATION OR THIS EULA. SOME JURISDICTIONS DO NOT ALLOW THE EXCLUSION OR LIMITATION OF INCIDENTAL OR CONSEQUENTIAL DAMAGES, SO THE ABOVE EXCLUSION OR LIMITATION MAY NOT APPLY TO YOU. THESE LIMITATIONS ARE INDEPENDENT FROM ALL OTHER PROVISIONS OF THIS EULA AND SHALL APPLY NOTWITHSTANDING THE FAILURE OF ANY REMEDY PROVIDED HEREIN.

7.3 Indemnification. You will defend, indemnify and hold harmless LeCroy and its officers, directors, affiliates, contractors, agents, and employees from, against and in respect of any and all assessments, damages, deficiencies, judgments, losses, obligations and liabilities (including costs of collection and reasonable attorneys' fees, expert witness fees and expenses) imposed upon or suffered or incurred by them arising from or related to your use of the Software Product.

8. GENERAL PROVISIONS.

8.1 Compliance with Laws. You will comply with all laws, legislation, rules, regulations, and governmental requirements with respect to the Software Product, and the performance by you of your obligations hereunder, of any jurisdiction in or from which you directly or indirectly cause the Software Product to be used or accessed.

8.2 No Agency. Nothing contained in this EULA will be deemed to constitute either party as the agent or representative of the other party, or both parties as joint venturers or partners for any purpose.

8.3 Entire Agreement; Waiver; Severability. This EULA constitutes the entire agreement between the parties with regard to the subject matter hereof. No provision of, right, power or privilege under this EULA will be deemed to have been waived by any act, delay, omission or acquiescence by LeCroy, its agents, or employees, but only by an instrument in writing signed by an authorized officer of LeCroy. No waiver by LeCroy of any breach or default of any provision of this EULA by you will be effective as to any other breach or default, whether of the same or any other provision and whether occurring prior to, concurrent with, or subsequent to the date of such waiver. If any provision of this EULA is declared by a court of competent jurisdiction to be invalid, illegal or unenforceable, such provision will be severed from this EULA and all the other provisions will remain in full force and effect.

8.4 Governing Law; Jurisdiction; Venue. This EULA will be governed by and construed in accordance with the laws of the State of New York, USA, without regard to its choice of law provisions. The United Nations Convention on Contracts for the International Sale of Goods will not apply to this EULA. Exclusive jurisdiction and venue for any litigation arising under this EULA is in the federal and state courts located in New York, New York, USA and both parties hereby consent to such jurisdiction and venue for this purpose.

8.5 Assignment. This EULA and the rights and obligations hereunder, may not be assigned, in whole or in part by you, except to a successor to the whole of your business, without the prior written consent of LeCroy. In the case of any permitted assignment or transfer of or under this EULA, this EULA or the relevant provisions will be binding upon, and inure to the benefit of, the successors, executors, heirs, representatives, administrators and assigns of the parties hereto.

8.6 Notices. All notices or other communications between LeCroy and you under this EULA will be in writing and delivered personally, sent by confirmed fax, by confirmed e-mail, by certified mail, postage prepaid and return receipt requested, or by a nationally recognized express delivery service. All notices will be in English and will be effective upon receipt.

8.7 Headings. The headings used in this EULA are intended for convenience only and will not be deemed to supersede or modify any provisions.

8.8 Acknowledgment. Licensee acknowledges that (a) it has read and understands this EULA, (b) it has had an opportunity to have its legal counsel review this EULA, (c) this EULA has the same force and effect as a signed agreement, and (d) issuance of this EULA does not constitute general publication of the Software Product or other Confidential Information.

[Top of Page](#)

VIRUS PROTECTION

Because your scope runs on a Windows-based PC platform, it must be protected from viruses, as with any PC on a corporate network. It is crucial that the scope be kept up to date with Windows Critical Updates, and that anti-virus software be installed and continually updated.

Visit <http://www.lecroy.com/dsosecurity> for more information regarding Windows Service Pack compatibility with LeCroy operating software, and related matters.

SPECIFICATIONS

Note: Specifications are subject to change without notice.

Vertical System

Bandwidth (-3 dB @ 50 ohms):

WaveSurfer 422 and 424	200 MHz
WaveSurfer 432 and 434	350 MHz
WaveSurfer 452 and 454	500 MHz

Input Channels: 4 (WaveSurfer 424, 434, 454); 2 (WaveSurfer 422, 432, 452)

Rise Time (typical):

WaveSurfer 422 and 424	1.75 ns
WaveSurfer 432 and 434	1.00 ns
WaveSurfer 452 and 454	750 ps

Bandwidth Limiters:

- Full
- 200 MHz
- 20 MHz (WaveSurfer 424/422)

Input Impedance: 1 Mohms // 16 pF or 50 ohms +/-1%

Input Coupling: DC 50 ohm, DC 1Mohm, GND, AC 1Mohm



Max Input Voltage: +/-400 V_{pk} (CAT I), +/-300 V_{pk} (CAT II)

Installation (Overvoltage) Category: CAT I

Vertical Resolution: 8 bits

Sensitivity: 50 ohms: 1 mV/div to 2 V/div; 1 Mohms: 1 mV/div to 10 V/div

DC Gain Accuracy: +/- (1.5% + 0.5% of full scale)

Offset Range:

+/-1 V @ 1.0 mV to 49 mV/div
+/-10 V @ 50 mV to 0.49 V/div
+/-100 V @ 0.5 V to 10 V/div

Offset Accuracy: +/- (1.0% + 0.5% of full scale + 1 mV)

Horizontal System

Timebases: Internal timebase common to 4 input channels

Time/div Range:

WaveSurfer 454/452	200 ps to 1000 s/div
WaveSurfer 434/432	500 ps to 1000 s/div
WaveSurfer 424/422	1 ns to 1000 s/div
Roll Mode	200 ms 1000 s/div

Math & Zoom Traces: 4 independent zoom traces; 1 math/zoom trace

Clock Accuracy: <= 10 ppm

Interpolator Resolution: 5 ps

Acquisition System

Single-shot Sample Rate/Ch: 1 GS/s

Sample Rate (RIS mode): 50 GS/s

2 Channel Max.: 2 GS/s

Standard Record Length: 500 kpts/Ch (interleaved); 250 kpts/Ch (all channels)

Max. Record Length (optional): 2 Mpts/Ch (interleaved); 1 Mpts/Ch (all channels)

Standard Capture Time: up to 250 μ s at full sample rate

Max. Capture Time (optional): up to 1 ms at full sample rate

Acquisition Processing

Averaging: Continuous averaging to 1 million sweeps

Enhanced Resolution (ERES) -- optional with MathSurfer package: from 8.5 to 11 bits vertical resolution

Envelope (Extrema) -- optional with MathSurfer package: Envelope, floor, roof for up to 1 million sweeps

Triggering System

Modes: Normal, Auto, Single, and Stop

Sources: Any input channel, External, Ext/10, or Line; slope, level, and coupling are unique to each source (except Line). Line input is not available for battery or DC operation.

Slope: CH1 to CH4, Ext, Ext/10: Positive, Negative, Window; Line (except DC/battery power): Positive, Negative

Coupling Modes: AC, DC, HF, HFRej, LFRRej (except Line trigger)

Pre-trigger Delay: 0 to 100% of horizontal time scale

Post-trigger Delay: 0 to 10,000 divisions

Holdoff by Time or Events: Up to 20 s, or from 1 to 99,999,999 events

Internal Trigger Range: +/-5 div from center

External Trigger Range: EXT/10 +/-5 V; EXT +/-500 mV

External Trigger Impedance: 50 ohms, 1 Mohms

Basic Triggers

Edge/Slope/Line: Triggers when the signal meets the slope (positive, negative, window) and level condition.

SMART Triggers -- Standard

Glitch: Triggers on positive or negative glitches with widths selectable from 600 ps to 20 s or on intermittent faults.

Width: Triggers on positive or negative glitches with widths selectable from 2 ns to 20 s or on intermittent faults. Includes exclusion mode (trigger on intermittent faults by specifying the normal width period).

Logic (Pattern): Logic combination (AND, NAND, OR, NOR) of 5 inputs (4 channels and external trigger input). Each source can be high, low, or don't care. The High and Low level can be selected independently. Triggers at start or end of pattern.

TV -- Composite Video: Triggers selectable fields (1, 2, 4, or 8), positive or negative slope, for NTSC, PAL, SECAM, or non-standard video (up to 1500 lines).

SMART Triggers -- Optional

Runt: Triggers on positive or negative runts defined by two voltage limits and two time limits. Select between 2 ns and 20 ns. Includes exclusion mode (trigger on intermittent faults by specifying the normal width period).

Slew Rate: Triggers on edge rates. Select limits for dV, dt, and slope. Select edge limits between 2 ns and 20 ns. Includes exclusion mode (trigger on intermittent faults by specifying the normal width period).

Interval (Signal or Pattern): Triggers on a source if a given state (or transition edge) has occurred on another source. Delay between sources is 2 ns to 20 s, or 1 to 99,999,999 events. Includes exclusion mode (trigger on intermittent faults by specifying the normal width period).

Dropout: Triggers if the input signal drops out for longer than a selectable timeout between 2 ns and 20 s. Includes exclusion mode (trigger on intermittent faults by specifying the normal width period).

Qualified (State or Edge): Triggers on any input source only if a defined state or edge occurred on another input source. Delay between sources is 2 ns to 20 s, or 1 to 99,999,999 events. Includes exclusion mode (trigger on intermittent faults by specifying the normal width period).

Automatic Setup

Autosetup: Automatically sets timebase, trigger, and sensitivity to display a wide range of repetitive signals.

Vertical Find Scale: Automatically sets the vertical sensitivity and offset for the selected channels to display a waveform with maximum dynamic range.

Documentation and Connectivity

Printing: Connect to any WindowsXP-compatible printer. Load any standard WindowsXP printer driver onto the unit as future needs require.

Email: Configure the unit to send an email of a screen image in a variety of formats, using MAPI (i.e., through a default email program) or SMTP (no additional program needed).

Waveform Memories: Save waveform data as a reference trace to be compared to channels, zooms, or math functions.

Waveform File Data: Save waveform data in the following formats: binary, ASCII, Excel, Mathcad, MATLAB.

Screen Images: Save a screen image to the internal hard drive, a user-supplied USB memory stick, or any other peripheral device connected to one of the three USB 2.0 ports. Images can be saved in a variety of formats, and with white or black background.

Waveform Labeling (Annotation): Attach up to 10 labels to any combination of waveforms. Labels appear on screen images.

Hardcopy Front Panel Button: Configure the front panel Hardcopy button to send an email, save a screen image, save waveform file data, and save to the clipboard.

Networking: Standard 10/100Base-T Ethernet interface (RJ-45 connector). Connect to any network using DHCP with automatically assigned IP address.

Remote Control: Via LeCroy Remote Command Set (via Ethernet)

USB Ports: 3 USB ports (one on front of instrument) support Windows compatible devices

External Monitor Port Standard: 15-pin D-Type female SVGA-compatible connector for external color parallel port 25-pin D-type female (Centronics)

Serial Port: 9-pin D-type male (not for remote oscilloscope control)

Audio Port: Mic Input, Line Input, Line Output

Probing

Probes: One PP007-WS per channel (standard). A variety of optional passive and active probes is available.



Caution

To avoid incorrect measurements, ensure that your probes have the correct model number (PP007-WS). Do not use probes with model number PP007 or PP007-WR. Only model PP007-WS will provide the specified performance.

Probe System – ProBus: Automatically detects and supports a wide variety of compatible probes.

Scale Factors: Automatically or manually selected depending on probe used

Color Waveform Display

Type: Color 10.4-inch flat panel TFT LCD with high resolution touch screen

Resolution: SVGA; 800 x 600 pixels

Real Time Clock: Date, hours, minutes, and seconds displayed with waveform; SNTP support to synchronize to precision internet clocks

Grid Styles: Single, XY, Single+XY

Waveform Display Styles: Sample dots joined or dots only

Analog Persistence Display

Analog and Color-graded Persistence: Variable saturation levels; stores each trace's persistence data in memory

Persistence Selections: Select analog or color.

Persistence Aging Time: From 500 ms to infinity

Sweeps Displayed: All accumulated or all accumulated with last trace highlighted

Zoom Expansion Traces

Display up to 4 Zoom traces.

Rapid Signal Processing

Processor: Intel Celeron 850 with MS WindowsXP Embedded platform

Internal Waveform Memory

Waveform: M1, M2, M3, M4 (Store full-length waveforms with 16 bits/data point.) Or save to any number of files (limited only by data storage media).

Setup Storage

Front Panel and Instrument Status: Save to the internal hard drive or to a USB connected peripheral device.

Auxiliary Output

Signal Types: Select from calibrator or control signals output from front panel.

Calibrator Signal: 1 kHz, 1 V square wave

Control Signals: trigger enabled, trigger out, or pass/fail

Auxiliary Input

Signal Types: Select External Trigger input on front panel. EXT: 100 mV/div; EXT/10: 1 V/div

Math Tools (standard)

Operators include sum, difference, product, ratio, and FFT (up to 25 kpts with power spectrum output and rectangular, Von Hann, and Flattop windows). One math function may be defined at a time.

Extended Math (MathSurfer option)

Adds chaining of two math functions, rescaling to different units, and the following additional math functions:

absolute value	integral
averaging (summed and continuous)	invert
derivative	reciprocal
envelope	roof
enhanced Resolution (to 11 bits)	square
floor	square root

Measure Tools (standard)

Display any 6 parameters together with statistics, including their average, high, low, and standard deviations. Measurements can be gated to focus on only a portion of the waveform.

amplitude	overshoot-
area	overshoot+
base	peak-to-peak
delay	period
duty cycle	rise 20-80%
fall 80-20%	rise time (10-90%)
fall time (90-10%)	rms
frequency	skew
maximum	std. deviation
mean	top
minimum	width

Pass/Fail Testing

Test multiple parameters against selectable parameter limits at the same time. Pass or fail conditions can initiate actions including: document to local or networked files, email the image of the failure, save waveforms, or send a pulse out at the front panel auxiliary BNC output.

General

Auto Calibration: Ensures specified DC and timing accuracy is maintained for 1 year minimum.

Power Requirements: The instrument operates from a single-phase, 100 to 240 V_{rms} (+/-10%) AC power source at 50/60 Hz (+/-5%), or single-phase 100 to 120 V_{rms} (+/-10%) AC power source at 400 Hz (+/-5%).

Voltage Range:	90 to 132 V _{rms}	90 to 264 V _{rms}
Frequency Range:	380 to 420 Hz	47 to 63 Hz

Power Consumption: On State: up to 200 VA (4-channel models) or 170 VA (2-channel models) depending on accessories installed

(probes, external printer, PC port plug-ins, etc.)

Physical Dimensions (HWD): 260 mm x 340 mm x 152 mm (10.25 in. x 13.4 in. x 6.0 in.); height measurement excludes foot pads

Net Weight: 6.8 kg (15 lbs.)

Warranty and Service

3-year warranty; calibration recommended yearly

Optional service programs include extended warranty, upgrades, and calibration services.

Environmental Characteristics

Temperature

Operating: 5 to 40 °C

Storage (non-operating): -20 to +60 °C

Humidity

Operating: 5 to 80% RH (non-condensing) at or below 30 °C; upper limit derates linearly to 55% RH (non-condensing) at 40 °C

Storage (non-operating): 5 to 95% RH (non-condensing) as tested per MIL-PRF-28800F

Altitude

Operating: Up to 3048 m (10,000 ft) at or below 25 °C

Storage (non-operating): Up to 12,192 m (40,000 ft)

Random Vibration

Operating: 0.31 g_{rms}, 5 Hz to 500 Hz, 15 minutes in each of 3 orthogonal axes

Non-operating: 2.4 g_{rms}, 5 to 500 Hz, 15 minutes in each of 3 orthogonal axes

Shock

Functional Shock: 20 g peak, half sine, 11 ms pulse, 3 shocks (positive and negative) in each of 3 orthogonal axes, 18 shocks total



Certifications

CE Approved, UL (Std. UL 3111-1) and cUL (Std. CSA C22.2 No. 1010-1) listed.

CE Declaration of Conformity

The oscilloscope meets requirements of EMC Directive 89/336/EEC for Electromagnetic Compatibility and Low Voltage Directive 73/23/EEC for Product Safety.

EMC Directive:	89/336/EEC EN61326-1:1997+A1:1998+A2:2001
----------------	--



Warning

This is a Class A product. In a domestic environment this product may cause radio interference, in which case the user may be required to take appropriate measures.

Low Voltage Directive:	73/23/EEC EN 61010-1:2001
Product Safety	Safety requirements for electrical equipment for measurement, control, and laboratory use. Installation Category II Pollution Degree 2 Protection Class 1

[Top of Page](#)

SAFETY REQUIREMENTS

[Safety Symbols and Terms](#)

[Operating Environment](#)

[Cooling](#)

[AC Power Source](#)

[Power and Ground Connections](#)

[On/Standby Switch](#)

[Calibration](#)

[Cleaning](#)

[Abnormal Conditions](#)

This section contains information and warnings that must be observed to keep the instrument operating in a correct and safe condition. You are required to follow generally accepted safety procedures in addition to the safety precautions specified in this section.

Safety Symbols and Terms

Where the following symbols or terms appear on the instrument's front or rear panels, or in this manual, they alert you to important safety considerations.



This symbol is used where caution is required. Refer to the accompanying information or documents in order to protect against personal injury or damage to the instrument.



This symbol warns of a potential risk of shock hazard.



This symbol is used to denote the measurement ground connection.



This symbol is used to denote a safety ground connection.



This symbol shows that the switch is a On/Standby switch. When it is pressed, the DSO's state toggles between Operating and Standby state. This switch is not a disconnect device. To completely remove power to the DSO, the power cord must be unplugged from the AC outlet after the DSO is placed in Standby state.



This symbol is used to denote "Alternating Current."

CAUTION

The CAUTION sign indicates a potential hazard. It calls attention to a procedure, practice or condition which, if not followed, could possibly cause damage to equipment. If a CAUTION is indicated, do not proceed until its conditions are fully understood and met.

WARNING

The WARNING sign indicates a potential hazard. It calls attention to a procedure, practice or condition which, if not followed, could possibly cause bodily injury or death. If a WARNING is indicated, do not proceed until its conditions are fully understood and met.

CAT I

Installation (Overvoltage) Category rating per EN 61010-1 safety standard and is applicable for the oscilloscope front panel measuring terminals. CAT I rated terminals must only be connected to source circuits in which measures are taken to limit transient voltages to an appropriately low level.

Operating Environment

The instrument is intended for indoor use and should be operated in a clean, dry environment with an ambient temperature within the range of 5 °C to 40 °C.

Note: Direct sunlight, radiators, and other heat sources should be taken into account when assessing the ambient temperature.

The design of the instrument has been verified to conform to EN 61010-1 safety standard per the following limits:



WARNING

The DSO must not be operated in explosive, dusty, or wet/damp atmospheres.

Installation (Overvoltage) Categories II (Mains Supply Connector) & I (Measuring Terminals)

Pollution Degree 2

Protection Class I

Note:

Installation (Overvoltage) Category II refers to local distribution level, which is applicable to equipment connected to the mains supply (AC power source).

Installation (Overvoltage) Category I refers to signal level, which is applicable to equipment measuring terminals that are connected to source circuits in which measures are taken to limit transient voltages to an appropriately low level.

Pollution Degree 2 refers to an operating environment where normally only dry non-conductive pollution occurs. Occasionally a temporary conductivity caused by condensation must be expected.

Protection Class I refers to a grounded equipment, in which protection against electric shock is achieved by Basic Insulation and by means of a connection to the protective ground conductor in the building wiring.



CAUTION

Protect the DSO's display touch screen from excessive impacts with foreign objects.



CAUTION

Do not exceed the maximum specified front panel terminal (CH1, CH2, CH3, CH4, EXT) voltage levels. Refer to Specifications for more details.



CAUTION

Do not connect or disconnect probes or test leads while they are connected to a voltage source.

Cooling Requirements

The instrument relies on forced air cooling with internal fans and ventilation openings. Care must be taken to avoid restricting the airflow around the apertures (fan holes) at the sides, front, and rear of the DSO. To ensure adequate ventilation it is required to leave a 10 cm (4 inch) minimum gap around the sides, front, and rear of the instrument.



CAUTION

Do not block the ventilation holes located on both sides and rear of the DSO.



CAUTION

Do not allow any foreign matter to enter the DSO through the ventilation holes, etc.

AC Power Source

The instrument operates from a single-phase, 100 to 240 V_{rms} (+/-10%) AC power source at 50/60 Hz (+/-5%), or single-phase 100 to 120 V_{rms} (+/-10%) AC power source at 400 Hz (+/-5%).

No manual voltage selection is required; the instrument automatically adapts to line voltage.

Depending on the accessories installed (front panel probes, PC port plug-ins, external printer, etc.), the instrument can draw up to 200 VA (4-channel models) or 170 VA (2-channel models).

Note:

The instrument automatically adapts itself to the AC line input within the following ranges:

Voltage Range:	90 to 264 V _{rms}	90 to 132 V _{rms}
Frequency Range:	47 to 63 Hz	380 to 420 Hz

Power and Ground Connections

The instrument is provided with a grounded cord set containing a molded three-terminal polarized plug and a standard IEC320 (Type C13) connector for making line voltage and safety ground connection. The AC inlet ground terminal is connected directly to



WARNING

the frame of the instrument. For adequate protection against electrical shock hazard, the power cord plug must be inserted into a mating AC outlet containing a safety ground contact. Use only the power cord specified for this instrument and certified for the country of use.

The DSO should be positioned to allow easy access to the socket-outlet. To completely remove power to the DSO, unplug the instrument's power cord from the AC outlet after the DSO is placed in Standby state.

In Standby state the DSO is still connected to the AC supply. The instrument can only be placed in a complete Power Off state by physically disconnecting the power cord from the AC supply. It is recommended that the power cord be unplugged from the AC outlet if the DSO is not being used for an extended period of time.

See [On/Standby Switch](#) for more information.

On/Standby Switch

The front panel On/Standby switch controls the operational state of the DSO. This toggle switch is activated by momentarily pressing and releasing it.

There are two basic DSO states: On or Standby. In the "On" state, the DSO, including its computer subsystems (CPU, hard drive, etc.) is fully powered and operational. In the "Standby" state, the DSO, including computer subsystems, is powered off with the exception of some "housekeeping" circuitry (approximately 2 watts dissipation).

Always use the On/Standby switch to place the DSO in Standby state so that it executes a proper shutdown process (including a Windows shutdown) to preserve settings before powering itself off. This can be accomplished by pressing and holding in the On/Standby switch for approximately 5 seconds.

Note: To power off completely, place the DSO in Standby state, then disconnect the power cord.

Calibration

The recommended calibration interval is one year. Calibration should be performed by qualified personnel only.

Cleaning

Clean only the exterior of the instrument, using a damp, soft cloth. Do not use chemicals or abrasive elements. Under no circumstances allow moisture to penetrate the instrument. To avoid electrical shock, unplug the power cord from the AC outlet before cleaning.

Abnormal Conditions

Operate the instrument only as intended by the manufacturer.

If you suspect the DSO's protection has been impaired, disconnect the power cord and secure the instrument against any unintended operation.

The DSO's protection is likely to be impaired if, for example, the instrument shows visible damage or has been subjected to severe transport stresses.

Proper use of the instrument depends on careful reading of all instructions and labels.

[Top of Page](#)

Electrical Shock Hazard!

Any interruption of the protective conductor inside or outside of the DSO, or disconnection of the safety ground terminal creates a hazardous situation.

Intentional interruption is prohibited.



CAUTION

The outer shells of the front panel terminals (CH1, CH2, CH3, CH4, EXT) are connected to the instrument's chassis and therefore to the safety ground.



WARNING

Electrical Shock Hazard!

No operator serviceable parts inside. Do not remove covers.

Refer servicing to qualified personnel.



WARNING

Any use of the DSO in a manner not specified by the manufacturer may impair the instrument's safety protection. The instrument and related accessories should not be directly connected to human subjects or used for patient monitoring.



FRONT PANEL CONTROLS

Front Panel Buttons and Knobs

The control buttons of the instrument's *front panel* are logically grouped into analog and special functional areas. Analog functions are included in the *Horizontal*, *Trigger*, and *Vertical* groups of control buttons and knobs.

Note: Some of the front panel knobs are also special function push buttons. By pressing the knobs, you can activate functions such as Find Level, Zero Vertical Offset, and Zero Delay. The **ADJUST** knob functions as a toggle between fine and coarse adjustment.

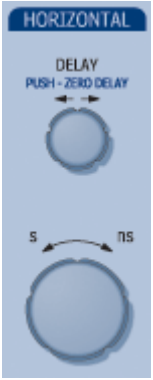
Sometimes you may want to change a value without using the numeric keypad. In that case, simply touch once inside the data entry field in the scope dialog area (the field will be highlighted in yellow), then use the *Adjust* knob to dial in values into the selected field.







<p>Trigger Control:</p> 	<p>The LEVEL knob selects the trigger threshold level. Push this knob to quickly find the level, which is indicated in the Trigger descriptor label.</p> <p>Press AUTO to display your trace. AUTO triggers the scope after a time-out, even if the trigger conditions are not met.</p> <p>NORMAL triggers the scope each time a signal is present that meets the conditions set for the type of trigger selected.</p> <p>SINGLE arms the scope to trigger once (single-shot acquisition) when the input signal meets the trigger conditions set for the type of trigger selected. If the scope is already armed, it will force a trigger.</p> <p>STOP prevents the scope from triggering on a signal. If you boot up the instrument with the trigger in Stop mode, the message "no trace available" will be displayed.</p>
<p>Horizontal Control:</p> 	<p>DELAY horizontally positions the scope trace on the display so you can observe the signal prior to the trigger time. It adjusts the pre- and post-trigger time. Push this knob to quickly set the delay to zero, in which case the trigger point is positioned in the middle of the display grid. When Zoom is selected, this button is used to position the zoom trace horizontally on the grid.</p> <p>Sets the time/division of the timebase (acquisition system).</p>
<p>Vertical Control:</p> 	<p>The VERTICAL OFFSET knob adjusts the vertical offset of a channel. Press the knobs to quickly set the offset to zero for the selected channel. When Zoom is selected, this button is used to position the zoom trace vertically on the grid.</p> <p>The VOLTS/DIVISION knob sets the vertical gain of the channel selected.</p> <p>The channel number buttons only turn a channel on or off; they do not display the setup dialog for the channel. A lighted channel button indicates that the channel trace is On and that the front panel controls are dedicated to that channel.</p> <p>To display a channel's setup dialog, select the channel from the Vertical drop-down menu. Or, touch the channel descriptor label twice.</p>
<p>Cursor Control:</p>	<p>The TYPE cursor button turns on cursors and, with each additional push, cycles through the different types -- horizontal (time) and vertical (amplitude), then turns them off. For an FFT math function, frequency cursors can also be displayed.</p>



The top and bottom knobs control the vertical and horizontal position of the cursors, depending on the type selected (vertical or horizontal). Cursors can be turned on by rotating either knob, and the cursors' position can be read in the Cursors Setup dialog (selectable from the menu bar) where you can also set both cursors to move in unison (tracking).

Push in the cursor control knobs at any time to return the cursors to their default starting positions.

Cursor values are displayed on-screen in the channel/trace descriptor labels and underneath the trigger and timebase descriptor labels.

Special Features:	
	<p>AUTO SETUP automatically sets the scope's horizontal timebase (acquisition system), vertical gain and offset, as well as trigger conditions, to display a wide variety of signals.</p>
	<p>ANALOG PERSIST provides a three dimensional view of the signal: time, voltage, and a third dimension related to the frequency of occurrence, as shown by a color-graded (thermal) or intensity-graded (analog) display. Push the button to turn persistence on, then continue pushing the button to cycle through analog and color-graded persistence, and finally to turn persistence off. When color-graded persistence is selected, you can rotate the knob to vary the saturation level.</p>
	<p>Pushing the MEASURE button opens the Measure dialog, which enables you to set up six parameter measurements with statistics. Push again to close the measure dialog.</p> <p>The QUICKZOOM button toggles zooms of all displayed channel traces on and off. If there is a math trace displayed when you push this button, the math trace will be automatically turned off to free a slot for a zoom trace.</p> <p>Pushing the MATH button opens the Math setup dialog and turns on the math trace. Push again to close the Math dialog.</p>
General Control:	
	<p>By default, the ADJUST knob makes coarse adjustments (that is, digits to the left of the decimal point). Press the <i>Adjust</i> knob to toggle to Fine and adjust digits to the right of the decimal point. To enter exact values, you can also display a <i>keypad</i> by touching twice inside a <i>data entry field</i>. Then use the keypad to type in the value.</p> <p>Note: You can set the granularity (delta) of the coarse adjustment by double-tapping inside the data entry field, then touching the Advanced checkbox in the pop-up numeric keypad. The keypad presents Coarse delta up/down buttons to set the delta:</p> <div data-bbox="326 1465 553 1633" data-label="Image"> </div> <p>In the pop-up keypad, be sure to leave the Fine checkbox unchecked to adjust the coarse delta.</p>
	<p>The printer button prints the displayed screen to a file, a printer, the clipboard, or sends it as e-mail. Select the device and format it in the Utilities - Hardcopy dialog.</p>
	<p>TOUCH SCREEN activates or deactivates the touch screen.</p>
	<p>CLEAR SWEEPS clears data from multiple sweeps (acquisitions) including: persistence trace displays, averaged traces, and parameter statistics.</p>

CLEAR
SWEEPS



[Top of Page](#)

ON-SCREEN TOOLBARS, ICONS, AND DIALOG BOXES

Menu Bar Buttons

The menu bar buttons at the top of the scope's display are designed for quick setup of common functions. At the right end of the menu bar is a quick setup button that, when touched, opens the setup dialog associated with the trace or parameter named beside it. The named trace or

parameter is the one whose setup dialog you last opened:



This button also appears as an undo button after front

panel buttons **AUTOSETUP** and **QUICKZOOM**



are pressed. If you want to perform an Undo operation, it must be the very next operation after you perform the Autosetup or QuickZoom operation.

Dialog Boxes

The dialog area occupies the bottom one-third of the screen. To expand the signal display area, you can minimize each dialog box by touching the **Close** tab at the right of the dialog box.

[Top of Page](#)

ALTERNATE ACCESS METHODS







The instrument often gives you more than one way to access dialogs and menus.

Mouse and Keyboard Operation

In the procedures we focus on front panel and touch-screen operation, but if you have a mouse connected to the instrument, you can also click on objects. Likewise, if you have a keyboard connected, you can use it instead of the virtual keyboard provided by the instrument.

Tool Bar Buttons

The procedures also focus on the use of the menu bar at the top of the screen to access dialogs and menus. However, on several dialogs common functions are accessible from a row of buttons that save you a step or two in accessing their dialogs. For example, at the bottom of the Channel Setup dialog, these buttons perform the following functions:

 A purple button with a white icon of a horizontal line with a vertical tick mark and a yellow arrow pointing to the right. The word "Measure" is written in white below the icon.	A pop-up menu allows you to select up to six measurements to compute on this channel without leaving the Channel Setup dialog. The parameter automatically appears below the grid.
 A purple button with a white icon of a magnifying glass over a yellow letter 'M'. The word "Zoom" is written in white below the icon.	Creates a zoom trace of the channel trace whose dialog is currently displayed.
 A purple button with a white icon of the mathematical function $f(x)$. The word "Math" is written in white below the icon.	A pop-up menu allows you to select a math function from this menu without leaving the Channel Setup dialog. A math trace of the channel whose dialog is currently open is automatically displayed.
 A purple button with a white icon of a storage chip with an arrow pointing to it. The word "Store" is written in white below the icon.	Loads the channel trace into the next available memory location (M1 to M4).
 A purple button with a white icon of a blue and yellow scale bar. The words "Find Scale" are written in white below the icon.	Automatically performs a vertical scaling that fits the waveform into the grid.
 A purple button with a white icon of a yellow label with a black arrow pointing to it. The word "Label" is written in white below the icon.	Opens a Labeling pop-up menu that allows you to create labels tied to the waveform.

[Top of Page](#)

TRACE DESCRIPTORS

Trace Annotation

To Turn On a Channel Trace Label

Vertical and horizontal trace descriptors (labels) are displayed below the grid. They provide a summary of your channel, timebase, and trigger settings. To make adjustments to these settings, touch the respective label to display the setup dialog for that function. Channel labels need to be touched twice unless they are active.

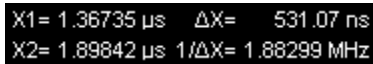
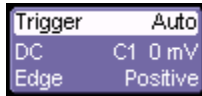
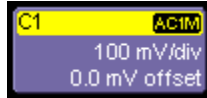

Channel trace labels show the vertical settings for the trace, as well as cursor information if cursors are in use. In the title bar of the label are also included indicators for deskew (DSQ), coupling (DC/GND), bandwidth limiting (BWL), and averaging (AVG). These indicators have a *long and short form*.

Besides channel traces, math and parameter measurement labels are also displayed. Labels are displayed only for traces that are turned on.

The title bar of the **TimeBase** label shows the trigger delay setting. Time per division and sampling information is given below the title bar.

The title bar of the **Trigger** label shows the trigger mode: Auto, Normal, or Stopped. Below the title bar is given the coupling (DC), trigger type (Edge), source (C1), level (0 mV), and slope (Positive).

Shown below the TimeBase and Trigger labels is setup information for horizontal cursors, including the time between cursors and the frequency.

Trace Annotation

The instrument gives you the ability to add an identifying label, bearing your own text, to a waveform display:

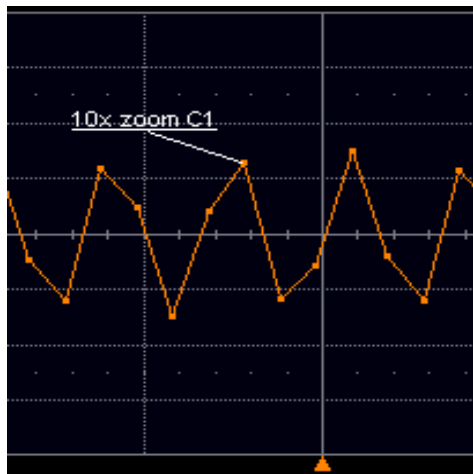

For each waveform, you can create multiple labels and turn them all on or all off. Also, you can position them on the waveform by dragging or by specifying an exact horizontal position.

To Annotate a Waveform

1. Touch the waveform you want to annotate, then **Set label...** in the pop-up menu. A *dialog box* opens in which to create the label. If you are creating a label for the first time for this waveform, **Label1** is displayed with default text. If you are modifying an existing label, under **Labels** touch the label you want to change.

Note 1: If the dialog for the trace you want to annotate is currently displayed, you can touch the label button  at the bottom to display the Trace Annotation setup dialog.

Note 2: You may place a label anywhere you want on the waveform. Labels are numbered sequentially according to the order in which they are added, and not according to their placement on the waveform.

2. If you want to change the label's text, touch inside the **Label Text** field. A pop-up keyboard appears for you to enter your text. Touch **O.K.** on the keyboard when you are done. Your edited text will automatically appear in the label on the waveform.
3. To place the label precisely, touch inside the **Horizontal Pos.** field and enter a horizontal value, using the pop-up numeric keypad.
4. To add another label, touch the **Add label** button. To delete a label, select the label from the list, then touch the **Remove label** button.
5. To make the labels visible, touch the **View labels** checkbox.

To Turn On a Trace

- On the front panel, press a channel select button, such as  , to display the trace label for that input channel and turn on the channel. Touch the channel trace label to open the dialog box.
- To turn on a math function trace, press the **MATH** front panel button or touch **Math** in the menu bar, then **Math Setup...** in the drop-down menu. Touch the **On** checkbox for the trace you want to activate.
- You can also quickly create traces (and turn on the trace label) for math functions and memory traces, without leaving the Vertical

Adjust dialog, by touching the icons at the bottom of the Vertical Adjust dialog:

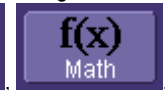

Whenever you turn on a channel, math, or memory trace via the menu bar, the dialog at the bottom of the screen automatically switches to the vertical setup or math setup dialog for that selection. You can configure your traces from here, including math setups.

The channel number appears in the tab of the "Vertical Adjust" dialog, signifying that all controls and data entry fields are dedicated to the selected trace.

[Top of Page](#)

SCREEN LAYOUT

The instrument's screen is divided into three areas:



- menu bar
- signal display area
- dialog area

Menu Bar

The top of the screen contains a toolbar of commonly used functions. Whenever you touch one of these buttons, the dialog area at the bottom of the screen switches to show the setup for that function.

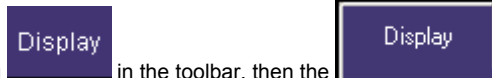
Signal Display Grid

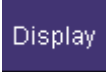

You can set up the signal display area by touching  in the toolbar, then the  tab. The display dialog offers a choice of grid combinations and a means to set the grid intensity.

Dialog Area

The lower portion is where you make selections and input data. The dialog area is controlled by both toolbar touch buttons and front panel push buttons.

[Top of Page](#)

HARDWARE INSTALLATION

Instrument I/O Panel

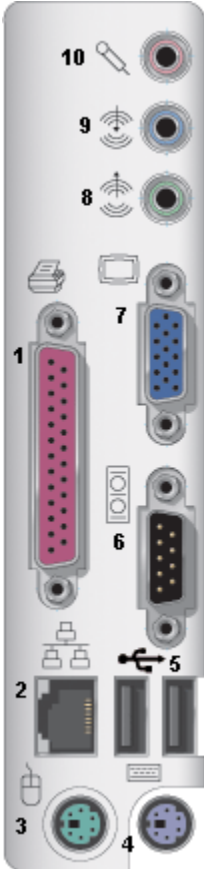

(1) Centronics Port; (2) Ethernet Port; (3) Mouse; (4) Keyboard; (5) USB Ports; (6) RS-232-C Port; (7) External VGA Monitor; (8) Line In; (9) Speakers; (10) Microphone

SOFTWARE

Checking the Scope Status

To find out the scope's software and hardware configuration, including software version and installed options, proceed as follows:

1. In the menu bar, touch .

2. Touch the  tab.

You can find information related to hard drive memory, etc. as follows:

1. Minimize the instrument application by touching , then selecting **Minimize** in the drop-down menu.
2. Touch the **Start** taskbar button and, per usual Windows® operation, open Windows Explorer.

[Top of Page](#)

DEFAULT SETTINGS

WaveMaster and WavePro 7000 Series DSOs

You can reset the scope to default settings by simply pressing the **DEFAULT SETUP** [push button](#) on the front panel. This feature turns on Channel1 and Channel 2, with no processing enabled.

Other default settings are as follows:

Vertical	Timebase	Trigger
50 mV/div	50.0 ns/div	DC50Ω (WaveMaster, DDA, SDA), AC1MΩ (WavePro), C1, 0 mV level
0 V offset	10.0 GS/s	edge trigger positive edge
	0 s delay	Auto trigger mode

DDA, SDA, and WaveRunner DSOs

On your front panel, the **DEFAULT SETUP** push button does not exist. For these instruments, therefore, to recall a default setup

1. Press the **SAVE/RECALL** push button to the left of the **DRIVE ANALYSIS** push button.

Note: You can also touch **File** in the menu bar, then **Recall Setup...** in the drop-down menu.



2. Touch the "Recall Setup" tab in the dialog.
3. Then touch the on-screen **Recall Default Setup** [button](#) .

[Top of Page](#)

ADDING A NEW OPTION

To add a software option you need a key code to enable the option. Call your local salesman or LeCroy Customer Support to place an order and receive the code.

To add the software option do the following:

1. In the menu bar, touch .
2. In the dialog area, touch the  tab.
3. Touch .
4. Use the pop-up keyboard to type the key code. Touch **O.K.** on the keyboard to enter the information.
5. The name of the feature you just installed is shown below the list of key codes. You can use the scroll buttons to see the name of the option installed with each key code listed:

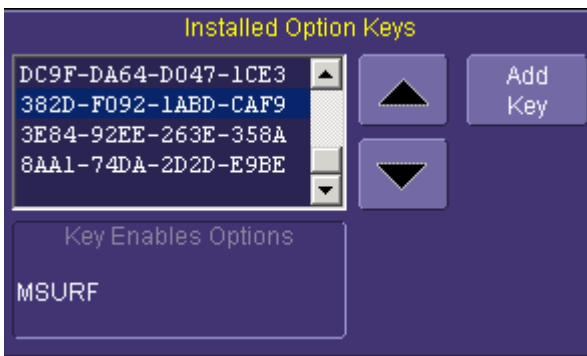

[Top of Page](#)

RESTORING SOFTWARE

Restarting the Application

Upon initial power-up, the scope will load the instrument application software automatically. If you exit the application and want to reload it,



touch the shortcut icon on the desktop:

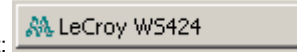

If you minimize the application, touch the appropriate task bar or desktop button to maximize it:



Restarting the Operating System

If you need to restart the Windows® operating system, you will have to reboot the scope by pressing and holding in the power switch for 10 seconds, then turning the power back on.

[Top of Page](#)

PROBUS INTERFACE





LeCroy's ProBus® probe system provides a complete measurement solution from probe tip to oscilloscope display. ProBus allows you to control transparent gain and offset directly from your front panel. It is particularly useful for voltage, differential, and current active probes. It uploads gain and offset correction factors from the ProBus EPROMs and automatically compensates to achieve fully calibrated measurements.

This intelligent interconnection between your instrument and a wide range of accessories offers important advantages over standard BNC and probe ring connections. ProBus ensures correct input coupling by auto-sensing the probe type, thereby eliminating the guesswork and errors that occur when attenuation or amplification factors are set manually.

[Top of Page](#)

AUXILIARY OUTPUT SIGNALS

In addition to a standard 1 V, 1 kHz calibration signal on the front panel, the following signals can be output through the AUX OUTPUT connector at the rear of the scope:

	Trigger Out -- can be used to trigger another scope.
	Trigger Enabled -- can be used as a gating function to trigger another instrument when the scope is ready.
	Pass/Fail -- allows you to set a pulse duration from 1 ms to 500 ms; generates a pulse when pass/fail testing is active and conditions are met.
	Aux Output Off -- turns off the auxiliary output signal.

To Set Up Auxiliary Output

1. In the menu bar, touch **Utilities**, then **Utilities Setup...** in the drop-down menu.
2. Touch the **Aux Output** tab.
3. Touch one of the buttons under **Use Auxiliary Output For**.

[Top of Page](#)

SAMPLING MODES

Depending on your timebase, you can choose either [Single-shot](#) (Real Time) , [RIS](#) , or [Roll](#)  mode sampling.

To Select a Sampling Mode

1. In the menu bar, touch **Timebase**, then **Horizontal Setup...** in the drop-down menu.
2. In the "Horizontal" dialog, touch a **Sample Mode** button.

[Top of Page](#)

SINGLE-SHOT SAMPLING MODE

[To Select a Sampling Mode](#)

Basic Capture Technique

A single-shot acquisition is a series of digitized voltage values sampled on the input signal at a uniform rate. It is also a series of measured data values associated with a single trigger event. The acquisition is typically stopped a defined number of samples after this event occurs: a number determined by the selected trigger delay and measured by the timebase. The waveform's horizontal position (and waveform display in general) is determined using the trigger event as the definition of time zero.

You can choose either a pre- or post-trigger delay. Pre-trigger delay is the time from the left-hand edge of the display grid forward to the trigger event, while post-trigger delay is the time back to the event. You can sample the waveform in a range starting well before the trigger event up to the moment the event occurs. This is 100% pre-trigger, and it allows you to see the waveform leading up to the point at which the trigger condition was met and the trigger occurred. (The instrument offers up to the maximum record length of points of pre-trigger information.) Post-trigger delay, on the other hand, allows you to sample the waveform starting at the equivalent of 10,000 divisions after the event occurred.

Because each instrument input channel has a dedicated ADC (Analog-to-Digital Converter), the voltage on each is sampled and measured at the same instant. This allows very reliable time measurements between the channels.

On fast timebase settings, the maximum single-shot sampling rate is used. But for slower timebases, the sampling rate is decreased and the number of data samples maintained.

The relationship between sample rate, memory, and time can be simply defined as:

$$\text{Capture Interval} = \frac{1}{\text{Sample Rate}} \times \text{Memory}$$

and

$$\frac{\text{Capture Interval}}{10} = \text{Time Per Division}$$

[Top of Page](#)

RIS SAMPLING MODE -- FOR HIGHER SAMPLE RATES

[To Select a Sampling Mode](#)

RIS (Random Interleaved Sampling) is an acquisition technique that allows effective sampling rates higher than the maximum single-shot sampling rate. It is used on repetitive waveforms with a stable trigger. The maximum effective sampling rate of 50 GS/s can be achieved with RIS by making 100 single-shot acquisitions at 500 MS/s. The bins thus acquired are positioned approximately 20 ps apart. The process of acquiring these bins and satisfying the time constraint is a random one. The relative time between ADC sampling instants and the event trigger provides the necessary variation, measured by the timebase to 5 ps resolution.

The instrument requires multiple triggers to complete an acquisition. The number depends on the sample rate: the higher the sample rate, the more triggers are required. It then interleaves these segments (see [figure](#)) to provide a waveform covering a time interval that is a multiple of the maximum single-shot sampling rate. However, the real-time interval over which the instrument collects the waveform data is much longer, and depends on the trigger rate and the amount of interleaving required. The oscilloscope is capable of acquiring approximately 40,000 RIS segments per second.

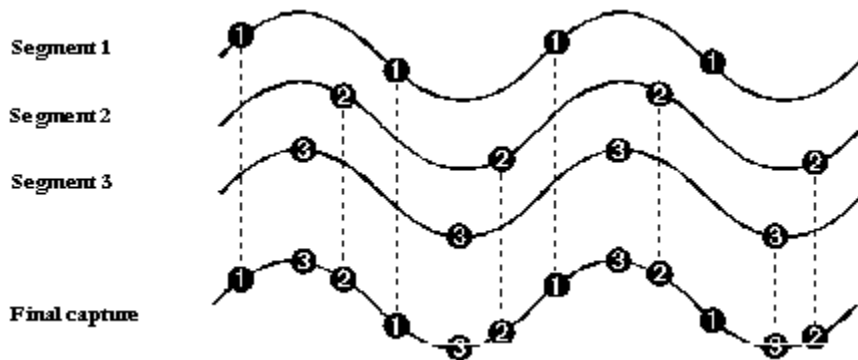

[Top of Page](#)

ROLL MODE

[To Select a Sampling Mode](#)

Roll mode can be selected when the timebase mode is real time, time per division is > 200 ms/div, and the sampling rate is < 200 kS/s.

Roll mode is selected automatically when the above criteria are met. Otherwise, the scope is in real-time mode.

Roll mode displays, in real time, incoming points in single-shot acquisitions that have a sufficiently low data rate. The oscilloscope rolls the incoming data continuously across the screen until a trigger event is detected and the acquisition is complete. The parameters or math functions connected to each channel are updated every time the roll mode buffer is updated, as if new data is available. This resets statistics on every step of Roll mode that is valid because of new data.

Note: If the processing time is greater than the acquire time, the data in memory gets overwritten. In this case, the instrument issues the warning: **Channel data is not continuous in ROLL mode!!!** and rolling will start over again.

[Top of Page](#)

ADJUSTING SENSITIVITY AND POSITION

To Adjust Sensitivity



1. Press the appropriate channel push button, for example  to select channel 1. Or touch the channel descriptor label.
2. Turn the *volts per division knob* for the selected channel. Or you can touch inside the Volts/Div field in the channel setup dialog and type in a value using the pop-up keypad, or use the up/down arrows.
3. The voltage that you set is displayed in the *trace descriptor label* and in the **Volts/Div** field.

To Adjust the Waveform's Position

Turn the vertical offset adjust knob. Or you can touch inside the **Offset** field and type in a value on the pop-up keypad. To set the vertical offset to zero press the front panel Offset button, or touch the Zero Offset button directly below the Offset field in the channel setup dialog.

[Top of Page](#)

COUPLING

The choices of coupling are as follows:

- DC 50 Ω
- GROUND
- DC 1 M Ω
- AC 1 M Ω

Note: The choices offered may differ if a ProBus® probe is connected to the instrument.

Overload Protection

The maximum input voltage is 4 V peak. Whenever the voltage exceeds this limit, the coupling mode automatically switches from DC 50 Ω to GROUND. You will then have to manually reset the coupling to DC 50 Ω , as described next.

To Set Coupling

1. In the menu bar, touch the **Vertical** button, then **Channel X Setup...** in the drop-down menu. Or you can touch the channel descriptor label twice.
2. Touch inside the **Coupling** field and select a coupling mode from the pop-up menu.

[Top of Page](#)

PROBE ATTENUATION

To Set Probe Attenuation

LeCroy's ProBus® system automatically senses probes and sets their attenuation for you. If you want to set the attenuation manually,

1. In the menu bar, touch **Vertical**, then select a channel from the drop-down menu.
2. Touch inside the **Probe Atten.** [data entry field](#) . Touch a divide-by menu selection or touch **Var** (variable). If you choose **Var**, type in a value using the pop-up numeric keypad.

[Top of Page](#)

BANDWIDTH LIMIT

Reducing the bandwidth also reduces the signal and system noise, and prevents high frequency aliasing.

To Set Bandwidth Limiting

To set bandwidth limiting

1. In the menu bar, touch **Vertical**, then select a channel from the drop-down menu. Or you can touch the channel descriptor label twice.
2. Touch inside the **Bandwidth** field and select a bandwidth limit value from the pop-up menu. The options are
 - Full
 - 200 MHz (not available on 200 MHz bandwidth models)
 - 20 MHz

[Top of Page](#)

QUICKZOOM

QuickZoom automatically displays a zoom of the channel or trace on a new grid.

To Turn On a Zoom



Touch the **Zoom** button in the channel dialog.

FINDING SCALE

You can access the **Find Scale** button from the channel setup dialog. This feature automatically calculates peak-to-peak voltage, and chooses an appropriate Volts/Div scale to fully display the waveform.

To Use Find Scale

1. Touch the trace label for the waveform you desire.
2. Touch the **Find Scale** icon.

VARIABLE GAIN

Variable Gain lets you change the granularity with which the gain is incremented. For example, when **Variable Gain** is disabled, the gain will increase or decrease in preset increments of 10 or 100 mV each time you touch the **Up/Down** buttons.

However, when **Variable Gain** is enabled, you can increase or decrease the gain in increments as small as 1 mV, depending on the scale of the waveform.

To Enable Variable Gain

1. Touch the descriptor label for the waveform whose gain you want to vary.
2. Touch the **Variable Gain** check box.

CHANNEL DESKEW

Unlike the Deskew math function, channel Deskew does no resampling, but instead adjusts the horizontal offset by the amount that you enter. The valid range is dependent on the current timebase +/- 9 divisions.

To Set Up Channel Deskew

1. In the menu bar, touch **Vertical**; from the drop-down menu, select a channel to set up.
2. Touch inside the **Deskew** data entry field and enter a value using the pop-up numeric keypad.

TIMEBASE SETUP AND CONTROL

Set up the timebase by using the front panel **Horizontal** controls, just as for analog scopes.

For additional timebase setups

1. Touch **Timebase** in the menu bar, then **Horizontal Setup...** in the drop-down menu. The "Horizontal" dialog appears.
2. Touch inside the **Time/Division** data entry field and enter a value using the pop-up numeric keypad, or use the up/down arrows to adjust the value.
3. Touch inside the **Delay** data entry field and type in a value, using the pop-up keypad. Touch the **Set To Zero** button to set the delay to zero.

DUAL CHANNEL ACQUISITION

Combining of Channels

During 4-channel operation, channels 1 and 2 or channels 3 and 4 are automatically combined to increase sample rate, memory, or both in order to capture and view a signal in all its detail. To maximize sampling rate when using only two channels, choose either channel 1 or 2 and either channel 3 or 4. When channels are combined, uncombined channels like EXT BNC remain available for triggering, even though they are not displayed.

[Top of Page](#)

AUTOSETUP

When channels are turned on, Autosetup operates only on those turned-on channels. If no channels are turned on, all channels are affected. When more than one channel is turned on, the first channel in numerical order with a signal applied to it is automatically set up for edge triggering.



You can perform an autosetup of all these functions together by simply pressing  on the front panel, or by touching **Autosetup**



in the Vertical, Timebase, or Trigger drop-down menu.

[Top of Page](#)

SIMPLE TRIGGERS

[To Set Up an Edge Trigger](#)

[To Set Up a SMART Trigger](#)

[Trigger Setup Considerations](#)

Edge Trigger on Simple Signals

The instrument uses many waveform capture techniques that trigger on features and conditions that you define. These triggers fall into two major categories:

- **Edge** – activated by basic waveform features or conditions such as a positive or negative slope, and hold-off
- **SMART Trigger®** – sophisticated triggers that enable you to use basic or complex conditions for triggering.

Use Edge Triggers for simple signals, and the SMART Triggers for signals with rare features, like glitches.

Control Edge Triggering

Horizontal: Turn the **DELAY** knob in the HORIZONTAL control group to adjust the trigger's horizontal position. Or, touch inside the **Delay** field in the timebase setup dialog and enter a value, using the pop-up keypad.



The trigger location is shown by a marker below the grid



Post-trigger delay is indicated by a left-pointing arrow below-left of the grid **C1**. The time value is given in the title line of the **TimeBase**

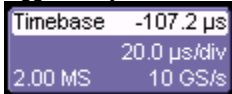

label below-right of the grid.

Vertical: Turn the **LEVEL knob** in the TRIGGER control group to adjust the trigger's vertical threshold.

Turn this knob to adjust the level of the trigger source or the highlighted trace. Level defines the source voltage at which the trigger will generate an event — a change in the input signal that satisfies the trigger conditions.

Alternatively, in the "Trigger" dialog, you can touch inside the **Level** field and type in a value, using the pop-up numeric keypad. To quickly set a level of zero volts, touch the **Zero Level** button directly below the **Coupling** field.

An arrow on the left side of the grid shows the threshold position. This arrow is only visible if the trigger source is displayed.

To Set Up an Edge Trigger

Channel Setup

1. In the menu bar, touch **Trigger**, then select **Trigger Setup...** from the drop-down menu.



2. Touch the **Edge** trigger button under the **Trigger** tab.
3. Touch inside the **Trigger On** data entry field and select an input from the pop-up **menu**.
4. Touch inside the **Level** data entry field. In the pop-up numeric keypad, enter a value in millivolts or use the **up/down buttons** to increase or decrease the value in increments of 1 mV. Or, touch one of the **preset value buttons**.

Max.	1.000 V
Default	0 mV
Min.	-1.000 V



5. Select the holdoff by touching the **Time** or **Events** buttons. Using the pop-up numeric keypad, enter a value and specify the **unit of time**, or use the **up/down buttons** to increase or decrease the time value in increments of 200 ps. Or, touch one of the **preset value buttons**.

The preset **Time** values are as follows:

Max.	20.0 s
-------------	--------

Default	50.0 ns
Min.	2 ns

The preset **Events** values are as follows:

Max.	1,000,000,000 events
Default	1 event
Min.	1 event

6. Choose **Positive** or **Negative** *slope* .

[Top of Page](#)

SMART TRIGGERS

[Glitch Trigger](#)

[Width Trigger](#)

[Interval Trigger](#)

[State Trigger](#)

[Qualified Trigger](#)

[Dropout Trigger](#)

[Logic Trigger](#)

[Runt Trigger](#)

[Slew Rate Trigger](#)

[TV Trigger](#)

[To Set Up Edge Trigger](#)

[Trigger Setup Considerations](#)



Width Trigger

[To Set Up Width Trigger](#)

How Width Trigger Works

Width trigger allows you to define a positive- or negative-going pulse width bounded by a voltage level, above or below which a trigger will occur. You can specify a pulse width and voltage range, within or outside of which a trigger will occur.

To Set Up Width Trigger

1. In the menu bar, touch **Trigger**, then **Trigger Setup...** in the drop-down menu.
2. Touch the **Smart Trigger** button.



3. Touch inside the **Type** field and select **Width** trigger.
4. Touch inside the **Trigger On** data entry field and select a *source* on which to trigger.
5. Touch inside the **Level** data entry field and enter a value using the pop-up numeric keypad.
6. Select positive or negative slope.
7. Touch the **LessThan** button and enter a pulse-width value in the **Upper Limit** data entry field.

Or touch the **GreaterThan** button and enter a pulse-width value in the **Lower Limit** data entry field.

Or touch the **InRange** button.



Touch the **Delta** button to set up a nominal range, plus or minus a delta value in seconds. Touch inside the **Nominal Width** and **Delta** data entry fields and enter values using the pop-up numeric keypads.



Alternatively, touch the **Limits** button to set up a precise pulse-width range. Touch inside the **Lower Limit** and **Upper Limit** data entry fields and enter values using the pop-up keypads.

Or touch the **OutOfRange** button and perform the same range setups as for InRange triggering.



Glitch Trigger

[To Set Up Glitch Trigger](#)

How Glitch Trigger Works

Glitch trigger can be used to catch glitches. You can specify a pulse width or a pulse width range.

Pulse smaller than selected pulse width: Set a maximum pulse width. This glitch trigger is generated on the selected edge (positive or negative) when the pulse width is less than or equal to the set width.

The timing for the width is initialized and restarted on the opposite slope to that selected. You can set widths from 600 ps to 20 s.

NOTE: If the glitch's width is narrower than the signal's width, set the trigger to a narrower width than that of the signal. The signal's width, as determined by the instrument trigger comparator, depends on the DC trigger level. If that level were to be set at the middle of a sine wave, for example, the width could then be considered as the half period. But if the level were higher, the signal's width would be considered to be less than the half period.

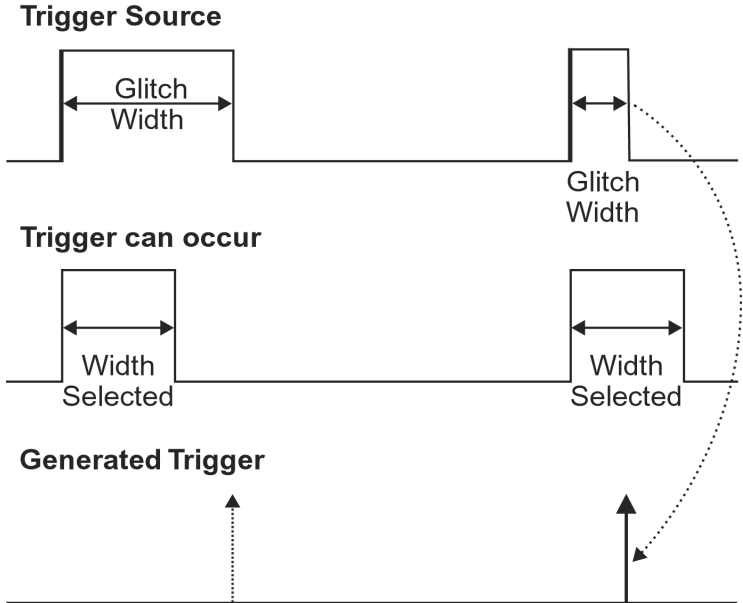

Glitch Trigger: In this example triggering on a pulse width less than or equal to the width selected. The broken upward-pointing arrow indicates a potential trigger, while the bold one shows where the actual trigger occurs.

To Set Up Glitch Trigger

1. In the menu bar, touch **Trigger**, then **Trigger Setup...** in the drop-down menu.
2. Touch the **Smart Trigger** button.
3. Touch inside the **Type** field and select **Glitch** trigger .
4. Touch inside the **Trigger On** data entry field and select a *source* on which to trigger.
5. Touch inside the **Level** data entry field and enter a value using the pop-up numeric keypad.
6. Select positive or negative slope.
7. Define the width of the glitch you are looking for. You can trigger on any glitch less than a chosen pulse-width (**Upper Limit**); or you can trigger on a chosen range (**InRange**). Touch the **LessThan** button; the **Upper Limit** data entry field alone is displayed. Touch the **InRange** button; the **Upper Limit** and **Lower Limit** fields are displayed.
8. Touch inside the limit field or fields and enter a time value using the pop-up numeric keypad.



Interval Trigger (optional with WS-ADVTRIG package)

To Set Up Interval Trigger

How Interval Triggers Work

While Glitch trigger performs over the width of a pulse, Interval trigger performs over the width of an interval, with the signal duration (period) separating two consecutive edges of the same polarity: positive to positive or negative to negative. Use Interval trigger to capture intervals that fall short of, or exceed, a given time limit. In addition, you can define a width range to capture any interval that is itself inside or outside the specified range: an exclusion trigger by interval.

Interval Less Than: For this Interval Trigger, generated on a time interval smaller than the one that you set, choose a maximum interval between two like edges of the same slope (positive, for example).

The trigger is generated on the second (positive) edge if it occurs within the set interval. The instrument initializes and restarts the timing for

the interval whenever the selected edge occurs. You can set an interval from 2 ns to 20 s.

Trigger Source: Positive Slope

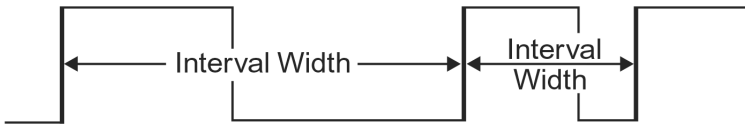

Trigger can occur



Generated Trigger



Interval Trigger that triggers when the interval width is smaller than the selected interval. The broken, upward-pointing arrow indicates a potential trigger, while the bold one shows where the actual trigger occurs — on the positive edge within the selected interval.

Interval Greater Than: For this Interval Trigger, generated on an interval larger than the one that you set, select a minimum interval between two edges of the same slope. The instrument generates the trigger on the second edge if it occurs after the set interval. The timing for the interval is initialized and restarted whenever the selected edge occurs. You can set an interval from 2 ns to 20 s.

Trigger Source: Positive Slope

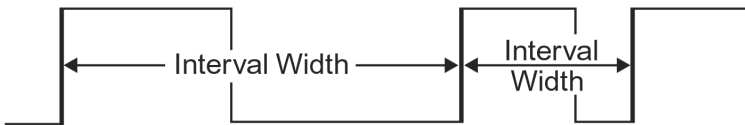

Trigger can occur



Generated Trigger



Interval Trigger that triggers when the interval width is larger than the set interval. The broken upward-pointing arrow indicates a potential trigger, while the bold one shows where the actual trigger occurs — on the positive edge after the selected interval.

Interval In Range: This Interval Trigger is generated whenever an interval between two edges of the same slope falls within a selected range. The instrument initializes and restarts the timing for the interval whenever the selected edge occurs. You can set an interval from 2 ns to 20 s.

Trigger Source: Positive Slope

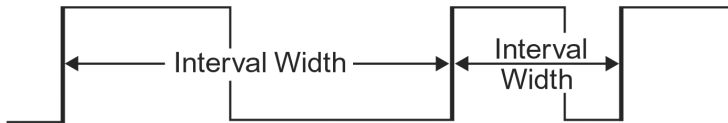

Trigger can occur

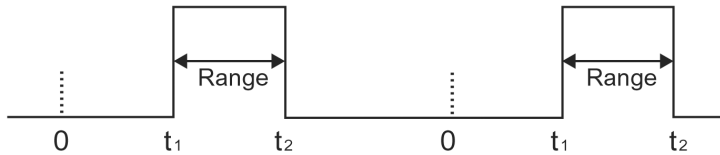

Generated Trigger



Interval Trigger that triggers when the interval falls within the selected range:

t_1 = range's lower time limit; t_2 = range's upper limit. The broken upward-pointing arrow indicates a potential trigger, while the bold one indicates where the actual trigger occurs — on the positive edge within the selected range.

To Set Up Interval Trigger

1. In the menu bar, touch **Trigger**, then **Trigger Setup...** in the drop-down menu.
2. Touch the **Smart Trigger** button.
3. Touch inside the **Type** field and select **Interval** trigger .
4. Touch inside the **Trigger On** data entry field and select a **source** on which to trigger.
5. Touch inside the **Level** data entry field and enter a value using the pop-up numeric keypad.
6. Select positive or negative slope.
7. Touch the **LessThan** button and enter a pulse-width value in the **Upper Limit** data entry field.

Or touch the **GreaterThan** button and enter a value in the **Lower Limit** data entry field.

Or touch the **InRange** button.



Touch the **Delta** button to set up a nominal range, plus or minus a delta value, in seconds. Touch inside the **Nominal Width** and **Delta** data entry fields and enter values using the pop-up numeric keypads.



Touch the **Limits** button to set up a precise range. Touch inside the **Lower Limit** and **Upper Limit** data entry fields and enter values using the pop-up numeric keypads.

Or touch the **OutOfRange** button and perform the same Delta or Limits setup as for InRange triggering.



Qualified Trigger (optional with WS-ADVTRIG package)

To Set Up Qualified Triggers

How Qualified Triggers Work

Use a signal's transition above or below a given level (its validation) as an enabling (qualifying) condition for a second signal that is the trigger source. These are Qualified triggers. For Edge Qualified triggers (the default) the transition is sufficient and no additional requirement is placed on the first signal. For State Qualified triggers the amplitude of the first signal must remain in the desired state until the trigger occurs. A qualified trigger can occur immediately after the validation, or following a predetermined time delay or number of potential trigger events. The time delay or trigger count is restarted with every validation.



Within Time creates a time window within which a trigger can occur.



Wait Time determines a delay from the start of the desired pattern. After the delay (timeout) and while the pattern is present, a trigger can occur. The timing for the delay is restarted when the selected pattern begins.



Events determines a minimum number of events of the trigger source. An event is generated when a trigger source meets its trigger conditions. On the selected event of the trigger source and while the pattern is present, a trigger can occur. The count is initialized and started whenever the selected pattern begins, and continues while the pattern remains. When the selected count is reached, the trigger occurs.

Trigger Source: Positive Slope

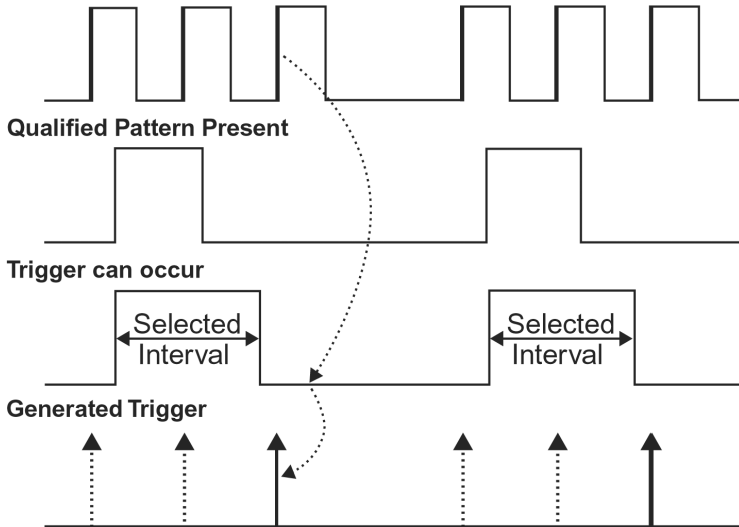

Edge Qualified and Wait: Trigger after timeout. The broken upward-pointing arrows indicate potential triggers, while the bold ones show where the actual triggers occur.

To Set Up an Edge Qualified Trigger

1. In the menu bar, touch **Trigger**, then **Trigger Setup...** in the drop-down menu.
2. Touch the **Smart Trigger** button.



3. Touch inside the **Type** field and select **Qualify** trigger.
4. Touch inside the **Trigger On** data entry field and select a **source** on which to trigger.
5. Select **Positive** or **Negative** slope.
6. Touch inside the **After** data entry field and select the qualifying signal source from the pop-up menu.

If you select an input channel or external source, touch inside the **has gone** data entry field and select a logic level: **Above** or **Below**. Then touch inside the **Qual Level** field and set a voltage level using the pop-up numeric keypad.



If you want to set a holdoff in time or events, touch one of the **Qualify by:** buttons:

7. Touch inside the field below the **Qualify by:** buttons and enter a value using the numeric keypad.



State Trigger

To Set Up a State Qualified Trigger

State trigger is another Qualified trigger; however, instead of using the edges of the qualifying inputs, State trigger uses the logic state of the inputs to qualify the trigger. Therefore, the pattern must become true and remain true (for a period of time or number of events that you specify) to qualify the trigger.

See also [How Qualified Triggers Work](#).

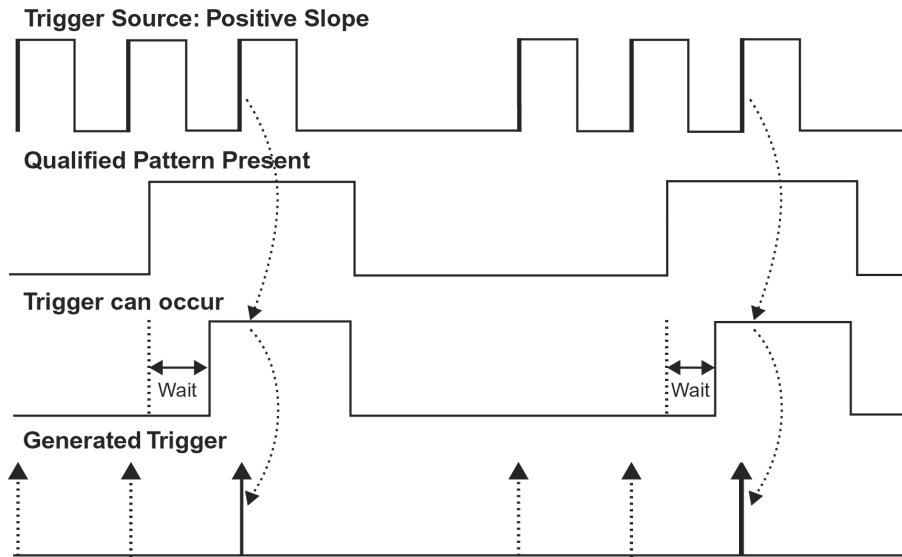

State Qualified and Wait: Trigger after timeout. The broken upward-pointing arrows indicate potential triggers, while the bold arrows show where the actual triggers occur.

To Set Up a State Qualified Trigger

1. In the menu bar, touch **Trigger**, then **Trigger Setup...** in the drop-down menu.
2. Touch the **Smart Trigger** button.



3. Touch inside the **Type** field and select **State** trigger.
4. Touch inside the **Trigger On** data entry field and select a *source* on which to trigger.
5. Select **Positive** or **Negative** slope.
6. Touch inside the **has gone** data entry field and select the qualifying signal source from the pop-up menu.

If you select an input channel or external source, touch inside the **has gone** data entry field and select a logic level: **Above** or **Below**. Then touch inside the **Qual Level** field and set a voltage level using the pop-up numeric keypad.



If you want to set a holdoff in time or events, touch one of the holdoff buttons:

7. Touch inside the field below the holdoff buttons and set a value using the numeric keypad.



Dropout Trigger (optional with WS-ADVTRIG package)

[To Set Up Dropout Trigger](#)

Used primarily in single-shot applications, and usually with a pre-trigger delay, Dropout trigger can detect lost signals. The trigger is generated at the end of the timeout period following the last trigger source transition. You can set a timeout period from 2 ns to 20 s.

How Dropout Trigger Works

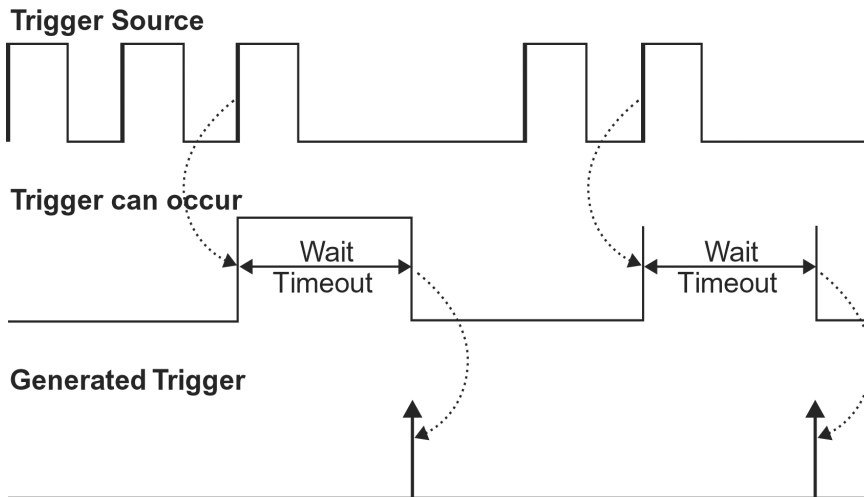

Dropout Trigger: occurs when the timeout has expired. The bold upward-pointing arrows show where the trigger occurs.

To Set Up Dropout Trigger

1. In the menu bar, touch **Trigger**, then **Trigger Setup...** in the drop-down menu.
2. Touch the **Smart Trigger** button.



3. Touch inside the **Type** field and select **Dropout** trigger.
4. Touch inside the **Trigger On** data entry field and select a **source** on which to trigger.
5. Select **Positive** or **Negative** slope.
6. Touch inside the **Level** field and enter a voltage value.
7. Touch inside the **Trigger after timeout** data entry field and enter a time window using the pop-up numeric keypad.



Logic Trigger

[To Set Up Logic Trigger](#)

How Logic Trigger Works

Logic Trigger enables triggering on a logical combination of up to five inputs: CH 1, CH 2, CH 3, CH 4, and EXT. The combination of inputs is referred to as a pattern. There are four logic gates available: AND, NAND, OR, NOR.

A trigger state is either high or low: high when a trigger source is greater than the trigger level (threshold) and low when less than it. For example, an AND pattern could be defined as true when the trigger state for CH 1 is high, CH 2 is low, and EXT is irrelevant (X or don't care). If any one of these conditions is not met, the pattern state is considered false. You can set holdoff limits from 2 ns to 20 s or from 1 to 1,000,000,000 events.

Logic Applications

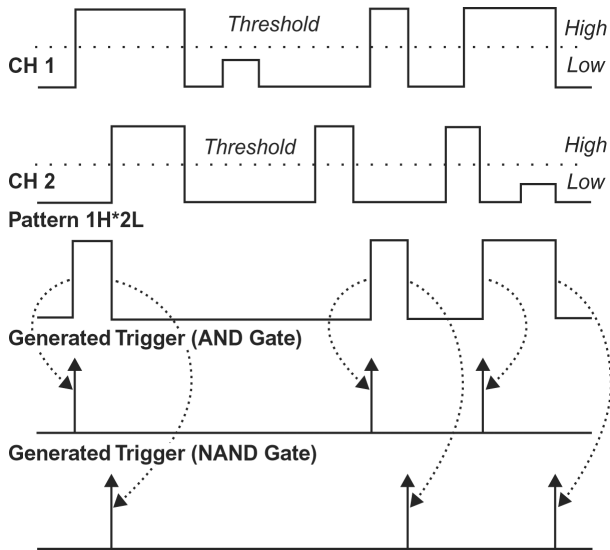

Logic Trigger can be used in digital design for the testing of complex logic inputs or data transmission buses.

To Set Up Logic Trigger

1. In the menu bar, touch **Trigger**, then **Trigger Setup...** in the drop-down menu.
2. Touch the **Smart Trigger** button.



3. Touch inside the **Type** field and select **Logic** trigger.
4. Touch the **Pattern** tab, and select a *logic gate*.
5. For each input you want to include in the logic pattern, touch inside the **State** field and select a logic state: Low or High. Select **Don't Care** for all other inputs.
6. Touch inside the **Level** data entry field for each input included in the pattern and enter a voltage level threshold using the pop-up numeric keypad.
7. Touch the **Trigger** tab.
8. If you want to hold off the trigger (either in time or events) when the pattern becomes true, touch one of the "Holdoff by" buttons



9. Touch inside the holdoff data entry field and enter a value using the pop-up numeric keypad.



Runt Trigger (optional with WS-ADVTRIG package)

[To Set Up Runt Trigger](#)

The runt trigger is programmed to occur when a pulse crosses a first threshold line and fails to cross a second threshold line before recrossing the first. You can select both voltage thresholds within a time range of 100 ps to 20 s. Other defining conditions for this trigger are the edge (triggers on the slope opposite to that selected) and runt width.

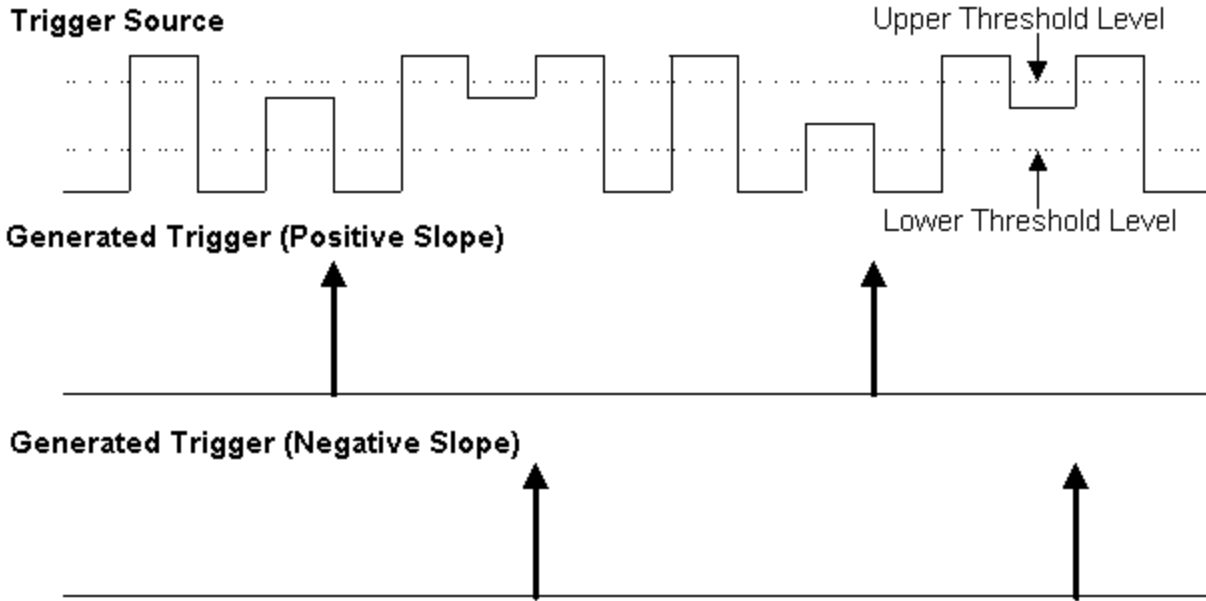

Runt trigger is particularly helpful for detecting meta-stable conditions in digital design.



Runt Trigger triggers when a pulse crosses the first threshold but not the second before recrossing the first (indicated by the bold, upward pointing arrows).

To Set Up Runt Trigger

1. In the menu bar, touch **Trigger**, then **Trigger Setup...** in the drop-down menu.
2. Touch the **Smart Trigger** button.
3. Touch inside the **Type** field and select **Runt** trigger .
4. Touch inside the **Trigger On** data entry field and select a source on which to trigger.
5. Select **Positive** or **Negative** slope.
6. To establish the upper and lower voltage thresholds, touch inside the **Lower Level** and **Upper Level** fields and enter a voltage into each field, using the pop-up keypad.
7. Choose a pulse width time constraint by touching one of the range buttons:

Less Than	Sets an upper limit for the pulse width from 2.5 ns to 20 s.
Greater Than	Sets a lower limit for the pulse width from 2.5 ns to 20 s.
In Range	 Touch the Delta button $w \pm s$ to set up a nominal range, plus or minus a delta value, in seconds. Enter time values into the Nominal Width and Delta data entry fields, using the pop-up numeric keypads.
Out of Range	 Touch the Limits button $t_l < w < t_u$ to set up a precise range. Enter time values into the Lower Limit and Upper Limit data entry fields, using the pop-up numeric keypads.



Slew Rate Trigger (optional with WS-ADVTRIG package)

To Set Up Slew Rate Trigger

Slew rate trigger activates a trigger when the rising or falling edge of a pulse crosses two threshold levels: an upper level and a lower level. The pulse edge must cross the thresholds faster or slower than a selected period of time. You can select both thresholds within a range of 2

ns to 20 s.

Trigger Source

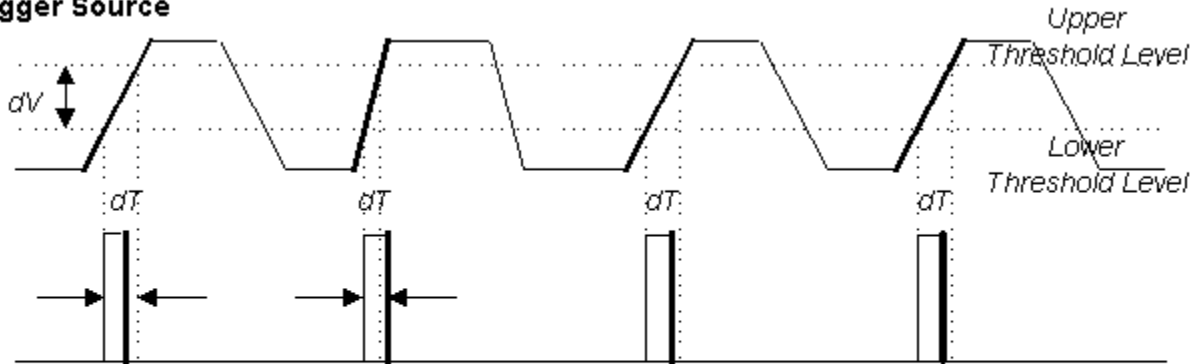

Generated Trigger



Slew Rate Trigger occurs when a rising or falling edge crosses two thresholds (dV) outside a selected time range (dT), indicated by the bold, upward pointing arrow.

To Set Up Slew Rate Trigger

1. In the menu bar, touch **Trigger**, then **Trigger Setup...** in the drop-down menu.
2. Touch the **Smart Trigger** button.



3. Touch inside the **Type** field and select **Slew Rate** trigger.
4. Touch inside the **Trigger On** data entry field and select a **source** on which to trigger.
5. Select **Positive** or **Negative** slope.
6. To establish the upper and lower voltage thresholds, touch inside the **Lower Level** and **Upper Level** fields and enter a value in each field, using the pop-up keypad.
7. Choose a pulse width time constraint by touching one of the range buttons:

Less Than	Sets an upper limit for the pulse width between 2 ns and 20 s.
Greater Than	Sets a lower limit for the pulse width between 2 ns and 20 s.
In Range	 Touch the Delta button to set up a nominal range, plus or minus a delta value, in seconds. Touch inside the Nominal Width and Delta data entry fields and enter values using the pop-up numeric keypads.
Out of Range	 Touch the Limits button to set up a precise range. Touch inside the Lower Limit and Upper Limit data entry fields and enter values using the pop-up numeric keypads.



TV Trigger

To Set Up TV Trigger

The WaveSurfer's TV triggers provide stable triggering on standard or custom composite video signals. Use them on PAL, SECAM, or NTSC systems. A composite video signal on the trigger input is analyzed to provide a signal for the beginning of the chosen field any, odd, or even

and for a signal at the beginning of each line. The field signal provides the starting transition, and the beginnings of line pulses are counted to allow the final trigger on the chosen line. For each field, the number of fields, the field rate, interlace factor, and number of lines per picture must be specified although there are standard settings for the most common types of TV signals. TV Trigger can also function in a simple any-line mode.

To Set Up TV Trigger

1. In the menu bar, touch **Trigger**, then **Trigger Setup...** in the drop-down menu.
2. Touch the **Smart Trigger** button.



3. Touch inside the **Type** field and select **TV trigger**.
4. Touch inside the **Trigger On** data entry field and select a **source** on which to trigger.
5. Select **Positive** or **Negative** slope.
6. Touch the **Trigger on Line ANY** checkbox if it is not important to specify any particular line. The controls dedicated to field and line setup become inactive.

Otherwise, leave the **Trigger on Line ANY** checkbox unchecked.

7. Touch inside the **# of fields** data entry field and make a selection from the pop-up menu: 1, 2, 4, or 8. Then enter a **Line** number and select a **Field**.
8. Touch one of the TV Standards buttons: .

<p>NTSC (525/60/2:1)</p>	<p>Use for standard 60-field NTSC signals. The lines can be selected in the range 1 to 263, where line 263 is identical to line 1.</p>
<p>PAL (625/50/2:1)</p>	<p>Use for most of the standard 50-field signals. The lines can be selected in the range 1 to 313, where line 313 is identical to line 1.</p>
<p>CUSTOM</p>	<p>Specify the number of lines (to 1500) and frequency, and set the interlacing factor for non-standard TV signals.</p>

DISPLAY SETUP

1. In the menu bar, touch **Display**; then touch **Display Setup** in the drop-down menu.
2. Touch one of the **Grid** *combination buttons* .
3. Touch inside the grid **Intensity** *data entry field* and enter a value from 0 to 100 using the pop-up keypad.
4. Touch the **Axis labels** checkbox to permanently display the values of the top and bottom grid lines (calculated from volts/div) and the extreme left and right grid lines (calculated from the timebase).
5. Choose a line style for your trace: solid *Line* or *Points* .

[Top of Page](#)

PERSISTENCE SETUP

The analog Persistence feature helps you display your waveform and reveal its idiosyncrasies or anomalies for a repetitive signal. Use Persistence to accumulate on-screen points from many acquisitions to see your signal change over time. The instrument's persistence modes show the most frequent signal path "three-dimensionally" in intensities of the same color, or graded in a spectrum of colors.

You can show persistence for up to eight inputs: any channel or memory location (M1 to M4) plus the math function trace.

[To Set Up Persistence](#)

Saturation Level

The Persistence display is generated by repeated sampling of the amplitudes of events over time, and the accumulation of the sampled data into "3-dimensional" display maps. These maps create an analog-style display. User-definable persistence duration can be used to view how the maps evolve proportionally over time. Statistical integrity is preserved because the duration (decay) is proportional to the persistence population for each amplitude or time combination in the data. In addition, the instrument gives you post-acquisition saturation control for a more detailed display.



When you select **Analog** mode from the Persistence dialog, a single color is used. As a persistence data map develops, different intensities of that color are assigned to the range between a minimum and a maximum population. The maximum population automatically gets the highest intensity, the minimum population gets the lowest intensity, and intermediate populations get intensities in between these extremes.

The information in the lower populations (for example, down at the noise level) could be of greater interest to you than the rest. The Analog persistence view highlights the distribution of data so that you can examine it in detail.

You can select a saturation level as a percentage of the maximum population. All populations above the saturation population are then assigned the highest color intensity: that is, they are saturated. At the same time, all populations below the saturation level are assigned the remaining intensities. Data populations are dynamically updated as data from new acquisitions is accumulated.



Color mode persistence, selected by touching the **Color** icon, works on the same principle as the Analog persistence feature, but instead uses the entire color spectrum to map signal intensity: violet for minimum population, red for maximum population. A saturation level of 100% spreads the intensity variation across the entire distribution; at lower saturation levels the intensity will saturate (become the brightest color) at the percentage value specified. Lowering this percentage causes the pixels to be saturated at a lower population, and makes visible those rarely hit pixels not seen at higher percentages.

Show Last Trace

For most applications, you may not want to show the last trace because it will be superimposed on top of your persistence display. In those cases turn off **Show Last Trace** by touching the checkbox. However, if you are doing mask testing and want to see where the last trace is falling, turn **Show Last Trace** on.

Persistence Time

You can control the duration of persistence by setting a time limit, in seconds, after which persistence data will be erased: 0.5 s, 1 s, 2 s, 5 s, 10 s, 20 s, or infinity.

To Set Up Persistence

From Front Panel



1. Push the **ANALOG PERSIST** knob. This will turn on persistence in the default analog mode.
2. Push the **ANALOG PERSIST** knob again to switch to color-graded persistence.
3. Turn the **ANALOG PERSIST** knob to vary the saturation from the default 50% value. To see the actual value, touch Display in the menu bar, then **Persistence Setup...** in the drop-down menu.
4. To turn persistence off, push the **ANALOG PERSIST** knob a third time.

From Persistence Dialog

1. In the menu bar touch **Display**, then touch **Persistence Setup...** in the drop-down menu.
2. Touch the **Persistence On** checkbox.
3. Touch inside the **Saturation** data entry field and enter a whole number integer, using the pop-up numeric keypad.
4. Touch inside the **Persistence time** data entry field and make a selection from the pop-up menu.

5. To turn off persistence, uncheck the **Persistence On** checkbox.

[Top of Page](#)

SCREEN SAVER

The Windows screen saver is activated in the same way as for any PC.



1. Minimize the instrument display by touching **File** in the menu bar, then **Minimize** in the drop-down menu.
2. Touch **Start** down in the task bar.
3. Touch **Settings** in the pop-up menu.
4. Touch **Control Panel**.
5. Touch **Display**.
6. Touch the **Screen Saver** tab.

ZOOMING WAVEFORMS

[To Zoom a Single Waveform](#)

[To Zoom by Touch and Drag](#)

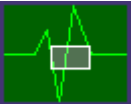
[To Turn Off Zoom](#)

	<p>The front panel "QuickZoom" button creates multiple zooms, one for each displayed input channel. A second push of the button turns all zooms off.</p>
	<p>At any time, you can also zoom a portion of a waveform by touching and dragging a rectangle around any part of the input waveform. The zoom trace will size itself to fit the full width of the grid. The degree of magnification, therefore, will depend on the size of the rectangle that you create.</p> <p>When you zoom a waveform, an approximation of the zoomed area will appear in a thumbnail icon in the "Zoom" dialog. The "Zoom" dialog appears alongside the math setup dialog when Zoom is the math or memory function selected.</p>
	<p>This button appears as a standard button at the bottom of the channel "Cx Vertical Adjust" setup dialog and the Math setup dialog in case you want to create a zoom trace of your waveform. The default magnification is x10 horizontally and x1 vertically. To vary the degree of magnification for a channel trace, touch the zoom descriptor <i>label</i> to display the zoom dialog for that channel. Then touch inside a Horizontal or Vertical data entry field to highlight it, and use the front panel ADJUST knob to dial in the magnification factor you want.</p> <div data-bbox="367 785 1446 995" style="border: 1px solid gray; padding: 5px;"><p>Note: The Variable checkbox <input checked="" type="checkbox"/> Var. in the Zoom dialog enables you to make small incremental adjustments (that is, digits to the right of the decimal point) when you are changing the Horizontal or Vertical Scale/div. This functions the same way as the fine adjust feature of the front panel ADJUST knob. Therefore, if you push the ADJUST knob to enable Fine (variable) adjust, the Var. checkbox will automatically become checked once you start rotating the knob. Conversely, if you check or uncheck the Var. checkbox, the ADJUST knob will reconfigure itself accordingly.</p></div> <p>To return to the default zoom conditions (x10 horizontally and x1 vertically), push the Horizontal DELAY and Vertical OFFSET knobs. Alternatively, touch the Reset Zoom button in the "Zoom" dialog to cancel zoom completely (x1 horizontally and vertically).</p> <p>For Math traces, a zoom control <i>mini-dialog</i> is provided at the right of the math trace setup dialog.</p> <p>To unzoom a Memory or Math trace, push the front panel Horizontal DELAY and Vertical OFFSET knobs, which resets the trace to x1.00 magnification. Alternatively, touch the Reset button in the "Zoom" dialog.</p> <p>To turn the Memory or Math trace off completely, uncheck the Trace On checkbox.</p>

To Zoom a Single Waveform

1. In the menu bar, touch **Vertical**; then touch a channel number in the drop-down menu. Alternatively, you can just touch the channel *trace label* for a displayed channel.



2. Touch  at the bottom of the "Cx Vertical Adjust dialog." A zoom trace will be created of the selected channel.
3. To vary the degree of zoom, touch the newly created Zx trace label. The setup dialog for the zoom trace opens. It shows the current horizontal and vertical zoom values.
4. Touch inside the Horizontal or Vertical **Scale/div** field to highlight it, then turn the front panel **ADJUST knob** (or the Horizontal **TIME/DIV** or Vertical **VOLTS/DIV** knobs) to change the zoom value. The changing value is displayed in the **Scale/div** field.

If you want to increase or decrease your horizontal or vertical zoom in small increments, touch the **Var.** checkbox to enable variable zooming. Now as you rotate the **ADJUST knob**, the degree of magnification will change by a small increment. To zoom in or out in 1-2-5 standard increments, leave the **Var.** checkbox unchecked.

Use the Horizontal **DELAY** and Vertical **OFFSET** knobs to move the zoom trace as desired. Or push these buttons in to quickly zero the delay and offset.

To set precise horizontal or vertical zoom factors, touch inside the appropriate **Scale/div** data entry field and enter a time-per-div value, using the pop-up numeric keypad.

To Zoom by Touch-and-Drag

1. Touch and drag a rectangle around any part of an input channel waveform, math trace, or memory trace. If you have more than one trace displayed, a pop-up "Rectangle Zoom Wizard" will appear offering you the choice to zoom one or more traces.

2. To vary the degree of zoom, touch the newly created **Zx** trace label. The setup dialog for the zoom trace opens. It shows the current horizontal and vertical zoom values.
3. Touch inside the Horizontal or Vertical **Scale/div** field to highlight it, then turn the front panel **ADJUST knob** to change the zoom value. The changing value is displayed in the **Scale/div** field.

If you want to increase or decrease your horizontal or vertical zoom in small increments, touch the **Var.** checkbox to enable variable zooming. Now as you rotate the **ADJUST knob**, the degree of magnification will change by a small increment. To zoom in or out in 1-2-5 standard increments, leave the **Var.** checkbox unchecked.

To set precise horizontal or vertical zoom factors, touch inside the appropriate **Scale/div** field and enter a time-per-div value, using the pop-up numeric keypad.

4. Turn the front panel Horizontal **DELAY** and Vertical **OFFSET** knobs to adjust the vertical and horizontal position of the zoom. Push the buttons to reset to zero delay and offset.

To Zoom Multiple Waveforms Quickly

Press the QuickZoom [button](#) on the front panel. Zooms of the channel traces will be displayed together in one grid.

To Turn Off Zoom

1. To turn off all channel zooms at once, push the front panel QuickZoom [button](#).
2. To turn off zooms selectively, touch the Zx trace [label](#) for the zoom you want to turn off. The zoom setup dialog opens.
3. Touch the **Trace On checkbox** to delete the check mark and disable the zoom trace.

[Top of Page](#)

XY DISPLAY

Use XY displays to measure the phase shift between otherwise identical signals. You can display either voltage on both axes or frequency on both axes. The traces must have the same X-axis. The shape of the resulting pattern reveals information about phase difference and frequency ratio.

To Set Up XY Displays

1. In the menu bar, touch **Display**; then touch **Display Setup...** in the drop-down menu.
2. Choose an XY display by touching one of the [XY display mode buttons](#). You have the choice of showing the two waveforms on just the XY grid, or you can also show the input waveforms on a single.
3. Touch inside the **Input X** and **Input Y** [fields](#) and select your input sources from the pop-up menus. The inputs can be any combination of channels, math functions, and memory locations.

SAVING AND RECALLING SCOPE SETTINGS

You can save or recall scope settings to or from hard disk, floppy disk, or LAN location.

To Save Scope Settings

1. In the menu bar, touch **File**; then touch **Save Setup...** in the drop-down menu. Or, press the **SAVE/RECALL** front panel button, then touch the "Save Setup" tab.
2. To **Save To File**, touch inside the **Save Instrument Settings** data entry field and use the pop-up keyboard to enter the path to the



destination folder. Or touch **Browse** to navigate to the destination folder. Then touch **Save Now!** below the data entry field. To save to folder **Internal Setups** on the scope's hard drive, touch inside a **SetupX** data entry field and use the pop-up keyboard to



enter a file name. Touch **Save** alongside the data entry field. The file is deposited in **D:\Internal Setups**, and the current date is displayed above the field.

To Recall Scope Settings

1. In the menu bar, touch **File**; then touch **Recall Setup...** in the drop-down menu.
2. To **Recall From File**, touch inside the **Recall panels from file** data entry field and use the pop-up keyboard to enter the path to the



source folder. Or touch **Browse** to navigate to the source folder. Then touch **Recall Now**



To recall settings from folder **D:\ Internal Setups** on the scope's hard drive, touch **Recall** alongside the file you want to recall.

To Recall Default Settings

1. In the menu bar, touch **File**; then touch **Recall Setup...** in the drop-down menu.



2. Touch the button under **Recall Default Setup**

The default settings are as follows:

Vertical	Timebase	Trigger
50 mV/div	50.0 ns/div	DC50Ω or AC1MΩ (model dependent), C1, 0 mV trigger level
0 V offset	5.0 or 10.0 GS/s (model dependent)	edge trigger positive edge
	0 s delay	Auto trigger mode

[Top of Page](#)

SAVING SCREEN IMAGES

You can send images to a hard copy printer or to storage media. Both types of output are done from the same dialog.

1. In the menu bar, touch **Utilities**, then **Utilities Setup...** in the drop-down menu.
2. Touch the **Hardcopy** tab.
3. Touch the **File *button*** .
4. Touch inside the **File Format** field and select a graphic file type.
5. Under **Colors**, touch the **Use Print Colors** checkbox if you want your waveforms to print in color with a white background. A white background saves printer toner.
6. Touch inside the **Directory** field and type in the path to the directory where you want the image stored, using the pop-up keyboard. Or you can touch the browse button and navigate there.
7. Touch inside the **File Name** field and type in a name for your image, using the pop-up keyboard.
8. Under **Include On Print**, touch inside the Hardcopy Area field and choose

Grid Area Only to exclude the dialog area from the image

DSO Window to include the dialog area

Full Screen to reduce the scope window and print the desktop also

9. Touch the **Print Now *button*** .

In addition to saving the image to file, you can also print out the image from a network or local printer, copy it to clipboard, or email the image.

[Top of Page](#)

SAVING AND RECALLING WAVEFORMS

Saving Waveforms

Quick Save to Internal Memory

Use this method to quickly store a channel trace in an internal memory location and to display it:

1. Touch the trace descriptor [label](#) to open the setup dialog for the trace you want to store.
2. Touch the **Store** [button](#) at the bottom of the screen. The stored memory trace will be displayed in the same grid as the original waveform.

The Channel 1 trace is stored in M1, Channel 2 in M2, etc. If there is another trace (such as a math trace) already stored in a targeted location, it will be overwritten.

General Save to Memory

1. In the menu bar, touch **File**; then touch **Save Waveform...** in the drop-down menu.



2. In the "Save Waveform" dialog, touch the **Save To** button.
3. Touch inside the **Source** field and select a source from the pop-up menu. The source can be any trace; for example, a channel (C1 to C4), the math function, or a waveform stored in non-volatile RAM (M1 to M4).
4. Touch inside the **Trace Title** data entry field if you want to change the default name of your waveforms. Use the pop-up keyboard to type in the new name.

Note: You can change the name but not the sequence number.



CAUTION

If you use a name that ends in a number instead of a letter, the instrument may truncate the number. This is because, by design, the first waveform is automatically numbered 0, the second 1, etc. For example, if you want to use waveform name "XYZ32" but it is not preceded by waveforms XYZ0 through XYZ31, the waveform will be renumbered with the next available number in the sequence.

If you need to use a number in your waveform's name, it is recommended that you append an alpha character at the end of the number : "XYZ32a" for example.

5. If you are saving to file, touch the **Data Format** field and select a format type from the [pop-up menu](#) .

If you select **ASCII** or **Excel**, also touch the **SubFormat** field and select either **Time Data** or **Time & Ampl**. Then touch the **Delimiter** field and select a delimiter character from the pop-up menu: comma, space, semicolon, or tab.

6. Touch the **Browse** button for the **Save file in directory** field and browse to the location where you want the file saved. The file name is assigned automatically and is shown below the field.



7. Touch

Auto Save

You can also enable Auto Save from this dialog by touching one of the [Auto Save buttons](#) : **Wrap** (old files overwritten) or **Fill** (no files overwritten).



CAUTION

If you select **Fill**, you can quickly use up all disk space on your hard disk.

Recalling Waveforms

1. In the menu bar, touch **File**; then touch **Recall Waveform...** in the drop-down menu.

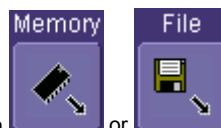

2. In the "Recall Waveform" dialog, touch the **Recall From** button.
 - A. If you selected **Memory**, touch inside the **Source** field and select a memory location: **M1** to **M4**.
 - B. If you selected **File**, touch inside the **Destination** field and select a memory location in which to store the file.
Touch inside the **Show only files** field and select an area to limit the search to: channels, math functions, or memory.
Touch inside the **Recall files from directory** data entry field and enter the path, using the pop-up keyboard. Or touch the

Browse button to navigate to the file.

Touch inside the **Next file will be recalled from** data entry field and enter the path, using the pop-up keyboard. Or touch the **Browse** button to navigate to the file.



3. Touch

[Top of Page](#)

DISK UTILITIES

Use the Disk Utilities dialog to delete files or create folders.

To Delete a Single File

1. Touch **File** in the menu bar, then **Disk Utilities...** in the drop-down menu.



2. Touch the **Delete** button in the "Disk Utilities" dialog.
3. Touch inside the **Current folder** data entry field and use the pop-up keyboard to enter the path to the folder that contains the file you want to delete.
Or touch the **Browse** button and navigate to the folder.
4. Touch inside the **File to be deleted** data entry field and use the pop-up keyboard to enter the name of the file.
Or touch the **Browse** button and navigate to the file.
5. Once you have located the file, touch the **Delete File** button.

To Delete All Files in a Folder

1. Touch **File** in the menu bar, then **Disk Utilities...** in the drop-down menu.



2. Touch the **Delete** button in the "Disk Utilities" dialog.
3. Touch inside the **Current folder** data entry field and use the pop-up keyboard to enter the path to the folder that contains the file you want to delete.
Or touch the **Browse** button and navigate to the folder.
4. Once you have located the folder, touch the **Empty Folder** button.

To Create a Folder

1. Touch **File** in the menu bar, then **Disk Utilities...** in the drop-down menu.



2. Touch the **Create** button in the "Disk Utilities" dialog.
3. Touch inside the **Current folder** data entry field and use the pop-up keyboard to enter the path to the directory you want to create the folder in, and the name of the folder.
4. Touch the **Create Folder** button.

[Top of Page](#)

PRINTING

To Set Up the Printer

1. In the menu bar, touch **File**, then **Print Setup...** in the drop-down menu. The Utilities **Hardcopy** dialog opens.



2. In the dialog area, touch the **Printer** icon.
3. Under **Colors**, touch the **Use Print Colors** checkbox if you want the traces printed on a white background. A white background saves printer toner. (You can change the printer colors in the Preference dialog;)
4. Touch inside the **Select Printer** field. From the touch pad pop-up choose the printer you want to print to. Touch the **Properties** button to see your printer setup.
5. Touch the icon for the layout **Orientation** you want: portrait or landscape.
6. Touch the **Grid Area Only** checkbox if you do not need to print the dialog area and you only want to show the waveforms and grids.

To Print

You can print in one of three ways:

- Press the printer button on the front panel:
- In the menu bar, touch **File**, then **Print** in the drop-down menu.
- Touch the **Print Now** button in the "Hardcopy" dialog

Adding Printers and Drivers

Note: If you want to add a printer driver, the driver must first be loaded on the scope.

1. In the menu bar, touch **File**, then **Print Setup...** in the drop-down menu. The Utilities **Hardcopy** dialog opens.



2. In the dialog area, touch the **Printer** icon.
3. Touch the **Add Printer** button. An MS Windows® window with which to add a printer will open.
4. Touch the Properties button to change printer properties such as number of copies.

Changing the Default Printer

1. If you want to change the default printer, minimize the instrument application by touching **File** in the menu bar, then **Minimize** in the drop-down menu.
2. Touch the **Start** button in the task bar at the bottom of the screen.
3. Select **Settings**, then **Printers**.
4. Touch the printer you want to set as the default printer, then touch **File**, **Set as Default Printer**.

[Top of Page](#)

MANAGING FILES

Use the instrument's utilities to create waveform files on floppy disk, internal hard drive or network drives. You can copy files from your hard drive to floppy disk. You also can give your files custom names and create directories for them.

Hard Disk Partitions

The instrument's hard disk is partitioned into drive **C:** and drive **D:**. Drive C: contains the Windows operating system and the instrument application software. Drive D: is intended for data files.

CONNECTING TO A NETWORK

Use the Ethernet connector (item 2 in the [I/O panel diagram](#)) to connect the instrument to a network.

COMMUNICATING OVER THE NETWORK

The instrument uses Dynamic Host Configuration Protocol (DHCP) as its addressing protocol. Therefore, there is no factory set IP address.

Windows Setups

If the instrument is to reside within a domain on your LAN, your IS administrator will have to connect the DSO.

Guidelines for Working in Windows

Although the instrument has an open architecture, avoid modifying the Windows operating system, since this may cause problems for the instrument's user interface. Please follow these recommendations:

- Do not load any version of Windows not provided by LeCroy. If you load any Windows XPe service packs from Microsoft, please be advised that LeCroy cannot guarantee trouble-free operation afterwards.
- If the instrument powers up in Windows Safe Mode, the touch screen will not function. You may need a mouse or keyboard to restore normal operation.
- Avoid modifying Control Panel settings.
- Do not change the color resolution (24 bit) or screen size (800 x 600 pixel) settings.
- After you load third-party software applications, if your scope does not work properly try reloading the instrument software from the CD shipped with the scope. If your instrument is not equipped with a CD drive, you will need a USB CD-ROM to do this (not supplied by LeCroy).
- Do not modify or remove any system fonts; doing so may affect the readability of the dialogs.
- Do not change any display properties like Background, Appearance, Effects, or Settings. Functionality of the scope or screen saver may be affected.
- Do not make any changes to the Windows folder.
- Do not make any changes to the BIOS settings.
- Do not make any changes to the Windows power management system.

System Restore

Although the scope creates regularly scheduled restore points automatically, before you install any hardware or software on your instrument, LeCroy strongly recommends that you manually create a restore point. The restore point resides on the scopes hard drive, so no external storage medium (floppy disk, USB memory stick, etc.) is required.

To Create a Restore Point

1. From the **File** menu, minimize or Window the scope display to reveal the task bar.
2. In the task bar, select **Start, Programs, Accessories, System Tools, System Restore**.
3. Touch the **Create a restore point** radio button, then touch **Next**.
4. In the **Restore point description** box, indicate what software or hardware is going to be added after the restore point is created, then touch **Next**.
5. The restore point will be created and a confirmation message will be displayed.

[Top of Page](#)

MEASURING WITH CURSORS

Cursors are important tools that aid you in measuring signal values. Cursors are markers — lines, cross-hairs, or arrows — that you can move around the grid or the waveform itself. Use cursors to make fast, accurate measurements and to eliminate guesswork. There are two basic types:

- **Horizontal** (Time) cursors are markers that you move horizontally along the waveform. Place them at a desired location along the time axis to read the signal's amplitude at the selected time.
- **Horizontal** (Frequency) cursors are markers that you move horizontally along an FFT math waveform. Place them at a desired location along the frequency axis to read the signal's amplitude in dB at the selected time.
- **Vertical** (Voltage) cursors are dashed lines that you move vertically on the grid to measure the amplitude of a signal.

[Cursors Setup](#)

[Top of Page](#)

CURSORS SETUP

Quick Display

At any time, you can change the display of cursor types (or turn them off) without invoking the "Cursors Setup" dialog as follows:



1. On the front panel, under "Cursors," turn either cursor control knob or push the **TYPE** button. This turns Horizontal (Time) cursors on. Push the **TYPE** button again to advance to Vertical (Amplitude) cursors. If you have an FFT math trace displayed, a third push of the **TYPE** button will switch the cursors to Frequency cursors; otherwise, it turns cursors off.

Alternatively, in the menu bar, touch **Cursors**, then **Off**, **Horizontal (Time)**, **Horizontal (Frequency)**, or **Vertical (Amplitude)** in the [drop-down menu](#). The cursors displayed will assume the positions previously set up.

2. Turn the upper and lower cursor control knobs to reposition the cursors on the grid. Push these buttons in at any time to return the cursors to their default starting positions.
3. Touch **Track On** in the menu bar **Cursors** drop-down menu if you want the cursors to move in unison under the control of a single cursor knob.

Full Setup

1. In the menu bar, touch **Cursors**, then **Cursors Setup**. The "Standard Cursors" dialog opens.
2. Touch one of the **Cursor Type** mode buttons. The cursors displayed will assume the positions previously set up.
3. Touch inside the **Position 1** and **Position 2** data entry fields and type in a value for each cursor.
4. If you would like both cursors to move in unison as you adjust the position, touch the **Track** checkbox to enable tracking.
5. Touch the **Find** buttons to position the cursors at predefined mid-level locations. The exact position of the cursors can be read in the **Position** fields.

[Top of Page](#)

OVERVIEW OF PARAMETERS

[To Turn On Parameters](#)

[Status Symbols](#)

[Statistics](#)

[Measure Gate](#)

[To Select a Parameter](#)

Parameters are measurement tools that determine a wide range of waveform properties. Use them to automatically calculate many attributes of your waveform, like rise-time, rms voltage, and peak-to-peak voltage, for example.

There are parameter modes for the amplitude and time domains, custom parameter groups, and parameters for pass and fail testing. You can make common measurements on one or more waveforms.

To Turn On Parameters



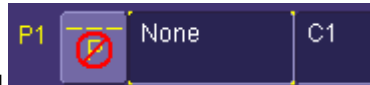

1. Press the **MEASURE** front panel button; or, touch **Measure** in the menu bar, then **Measure Setup...** in the drop-down menu.



2. For each parameter you want to display, touch inside the parameter field and make a selection from the pop-up menu. Then touch inside the source field and select a channel, memory, zoom, or the math function.

Status Symbols

Below each parameter appears a symbol that indicates the status of the parameter, as follows:

	A green check mark means that the scope is returning a valid value.
	A crossed-out pulse means that the scope is unable to determine top and base; however, the measurement could still be valid.
	A downward pointing arrow indicates an underflow condition.
	An upward pointing arrow indicates an overflow condition.
	An upward-and-downward pointing arrow indicates an underflow and overflow condition.

Using X-Stream Browser to Obtain Status Information

Example:

Here is a case of an overflow condition, in which the amplitude of the waveform cannot be determined:



1. Minimize the scope display by selecting **File** → **Minimize**.
2. Touch the **X-Stream Browser** desktop [icon](#) to open the browser.

3. Touch the left scope icon ("Connect to a local X-Stream DSO device") in the X-Stream Browser toolbar:



4. Select

Measure
Parameter in error (P1)
Out
Result

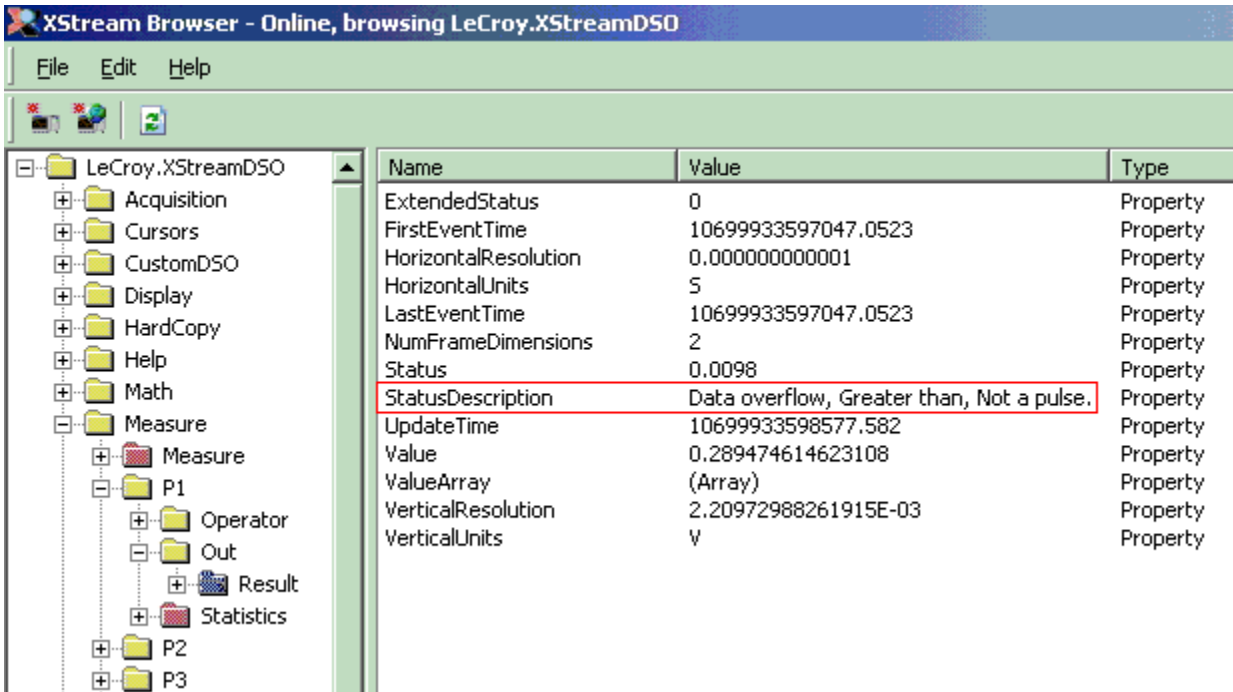

5. Read the status information in line **StatusDescription**.

Statistics

By touching the **Statistics On** checkbox in the "Measure" dialog, you can display statistics for standard vertical or horizontal parameters, or for custom parameters. The statistics that are displayed are as follows:

value (last)
mean
min.
max.
sdev
num

The values displayed in the **num** row is the number of measurements computed. For any parameter that computes on an entire waveform (like edge@level, mean, minimum, maximum, etc.) the value displayed represents the number of sweeps.

For any parameter that computes on every event, the value displayed is equal to the number of events per acquired waveform. If x waveforms were acquired, the value represents x times the number of cycles per waveform. Also, the "value" is equal to the measurement of the last cycle on the last acquisition.

Statistics continue to accumulate with each additional trigger until **Clear Sweeps** (either on the front panel or in the Measure menu) is activated, or a control (Volts/div, for example) is changed.

Measure Gate

[To Set Up Measure Gate](#)

Using Measure Gate, you can narrow the span of the waveform on which to perform parameter measurements, allowing you to focus on the area of greatest interest. One gate serves all parameters; i.e., there is not a separate gate for each parameter.

You have the option of dragging the gate posts horizontally along the waveform, or specifying a position down to hundredths of a division. The default starting positions of the gate posts are 0 div and 10 div, which coincide with the left and right ends of the grid. The gate, therefore, initially encloses the entire waveform.

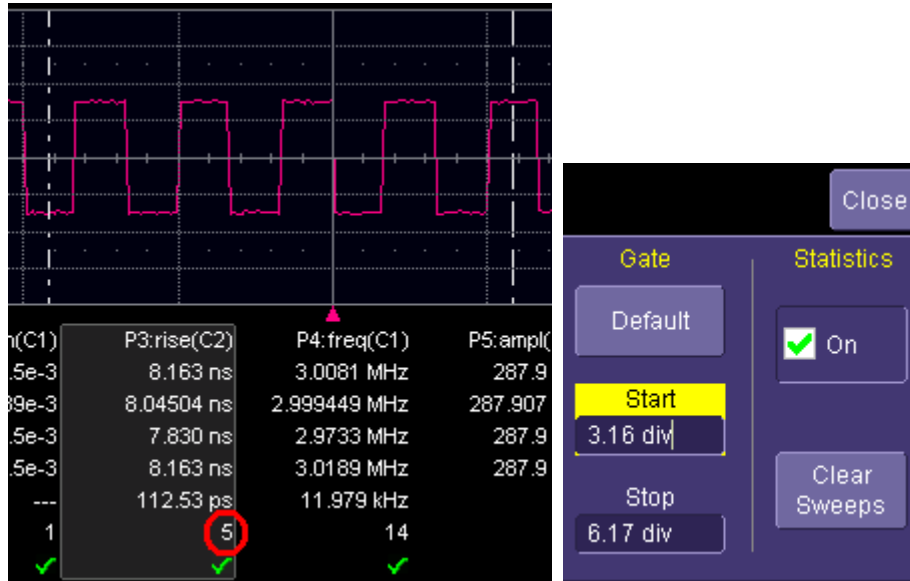

In this example, you can see that the Measure Gate includes only five rising edges. Therefore, parameter calculations for rise time are performed only on the five pulses bounded by the gate posts. The position of the gate posts is shown in the **Start** and **Stop** fields in the accompanying dialog.

To Set Up Measure Gate

1. In the menu bar, touch **Measure Setup...**
3. Touch inside the **Start** data entry field and enter a value, using the front panel **ADJUST** knob or pop-up numeric keypad. Or, you can simply touch the leftmost grid line and drag the gate post to the right.
4. Touch inside the **Stop** data entry field and enter a value, using the front panel **ADJUST** knob or pop-up numeric keypad. Or, you can simply touch the rightmost grid line and drag the gate post to the left.

To Select a Parameter

From a Vertical Setup Dialog

1. In the "Cx Vertical Adjust" dialog, touch the **Measure** button.
2. Select a parameter from the pop-up menu. The parameter is assigned to the next "available" parameter, or the last one if all are used.
3. Select another "Px" location and parameter, or touch **Close**.

From a Math Setup Dialog

1. In the "Math" dialog, touch the **Measure** button.
2. Select a parameter from the pop-up menu. The parameter is assigned to the next "available" parameter, or the last one if all are used.
3. Select another "Px" location and parameter, or touch **Close**.

From a Zoom Setup Dialog

1. Create a zoom trace by pushing the front panel QuickZoom button.

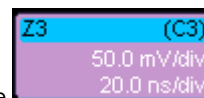

2. Touch the descriptor label for the zoom trace you want to measure, for example **Z3**. This will open the setup dialog for that zoom trace.
3. In the "Zx" dialog, touch the **Measure** button.
4. Select a parameter from the pop-up menu. The parameter is assigned to the next available Px location, or the last one if all are used.
5. Select another "Px" location and parameter, or touch **Close**.

PARAMETER CALCULATIONS

[Determining Top and Base Lines](#)

[Determining Rise and Fall Times](#)

[Determining Time Parameters](#)

[Determining Time Differential Measurements](#)

Parameters and How They Work

Determining Top and Base Lines

Proper determination of the top and base reference lines is fundamental for ensuring correct parameter calculations. The analysis begins by computing a histogram of the waveform data over the time interval spanned by the left and right time cursors. For example, the histogram of a waveform transitioning in two states will contain two peaks (see [Figure 1](#)). The analysis will attempt to identify the two clusters that contain the largest data density. Then the most probable state (centroids) associated with these two clusters will be computed to determine the top and base reference levels: the top line corresponds to the top and the base line to the bottom centroid.

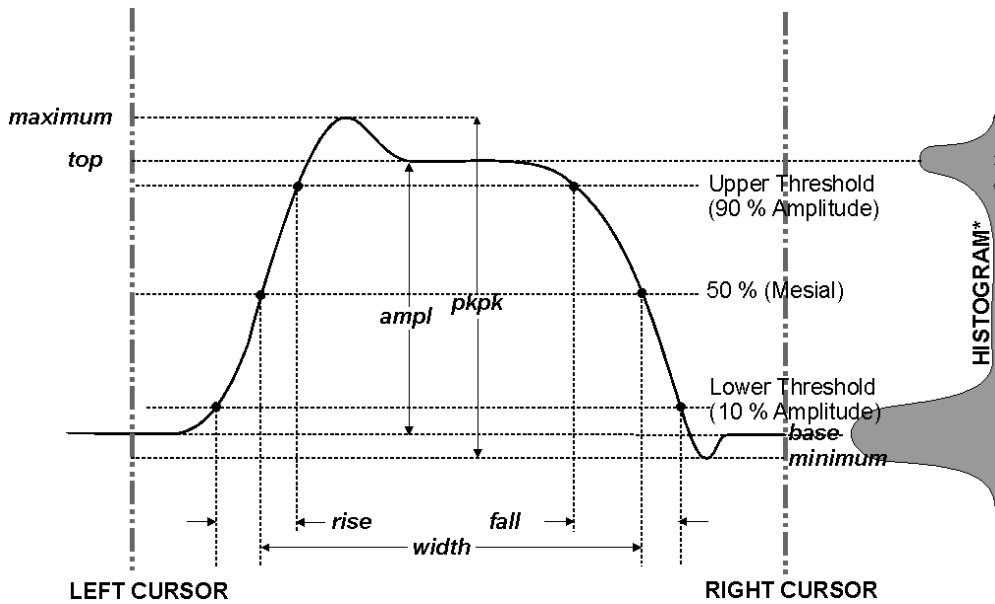

Figure 1

Determining Rise and Fall Times

Once top and base are estimated, calculation of the rise and fall times is easily done (see [Figure 1](#)). The 90% and 10% threshold levels are automatically determined by the DDA-5005, using the amplitude (ampl) parameter.

Threshold levels for rise or fall time can also be selected using absolute or relative settings (r@level, f@level). If absolute settings are chosen, the rise or fall time is measured as the time interval separating the two crossing points on a rising or falling edge. But when relative settings are chosen, the vertical interval spanned between the base and top lines is subdivided into a percentile scale (base = 0 %, top = 100 %) to determine the vertical position of the crossing points.

The time interval separating the points on the rising or falling edges is then estimated to yield the rise or fall time. These results are averaged over the number of transition edges that occur within the observation window.

Rising Edge Duration	$\frac{1}{M_r} \sum_{i=1}^{M_r} (T_{r_i}^{90} - T_{r_i}^{10})$
Falling Edge Duration	$\frac{1}{M_f} \sum_{i=1}^{M_f} (T_{f_i}^{10} - T_{f_i}^{90})$
Where M_r is the number of leading edges found, M_f the number of trailing edges found, $T_{r_i}^x$ the time when rising edge i crosses the $x\%$ level, $T_{f_i}^x$ and the time when falling edge i crosses the $x\%$ level.	

Determining Time Parameters

Time parameter measurements such as width, period and delay are carried out with respect to the mesial reference level (see [Figure 2](#)), located halfway (50%) between the top and base reference lines.

Time-parameter estimation depends on the number of cycles included within the observation window. If the number of cycles is not an integer, parameter measurements such as rms or mean will be biased. However, only the last value is actually displayed, the mean being available when statistics are enabled. To avoid these bias effects, the instrument uses cyclic parameters, including crms and cmean, that restrict the calculation to an integer number of cycles.

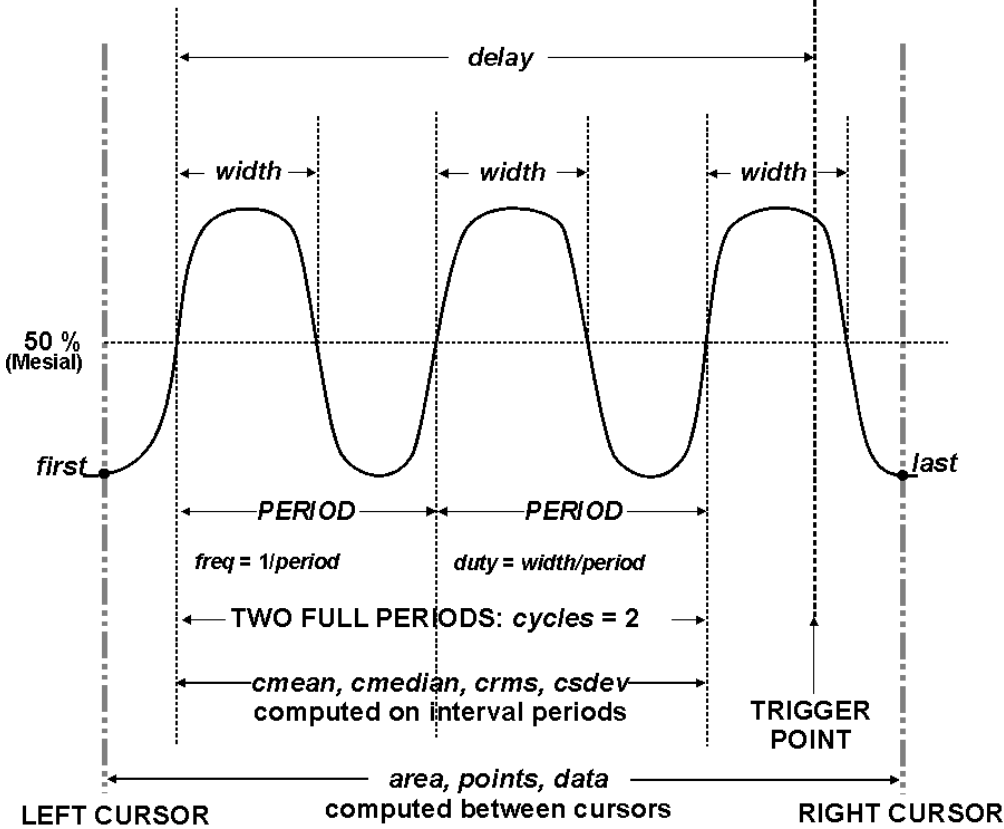

Figure 2

Determining Differential Time Measurements

The DDA-5005 enables accurate differential time measurements between two traces: for example, propagation, setup and hold delays (see [Figure 3](#)).

Parameters such as $\Delta c2d\pm$ require the transition polarity of the clock and data signals to be specified.

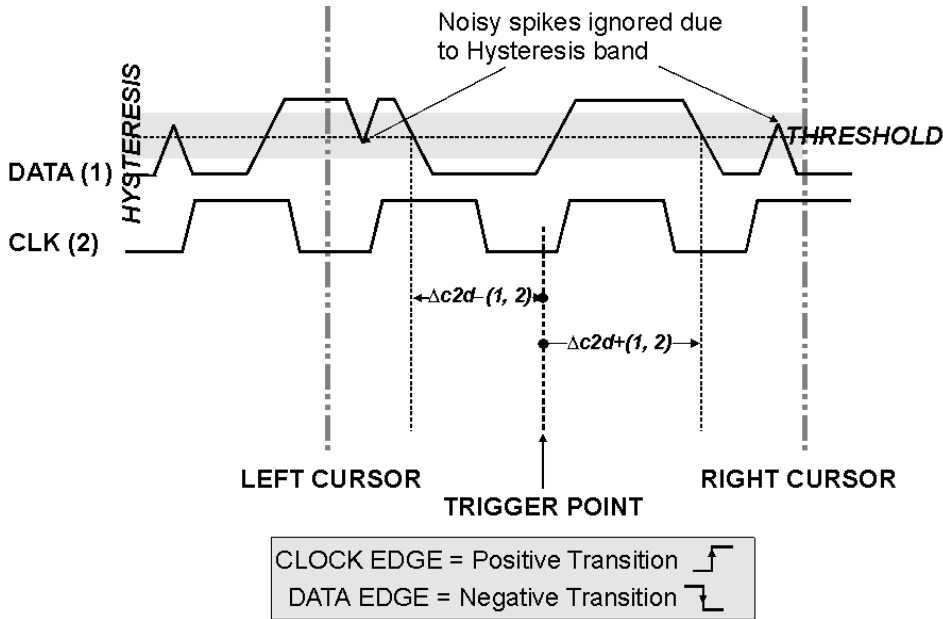

Figure 3

Moreover, a hysteresis range may be specified to ignore any spurious transition that does not exceed the boundaries of the hysteresis interval.

In [Figure 3](#), Delta c2d- (1, 2) measures the time interval separating the rising edge of the clock (trigger) from the first negative transition of the data signal. Similarly, Delta c2d+ (1, 2) measures the time interval between the trigger and the next transition of the data signal.

Level and Slope

For several time based measurements, you can choose positive, negative, or both slopes to begin parameter measurements. For two-input parameters, such as Dtime@level, you can specify the slope for each input, as well as the level and type (percent or absolute).

[Top of Page](#)

LIST OF PARAMETERS

The following table describes the instrument parameters. Availability of some parameters depends on the options installed. See the comments in the "Notes" column of the table.

Parameter	Description	Definition	Notes															
Amplitude	Measures the difference between upper and lower levels in two-level signals. Differs from pkpk in that noise, overshoot, undershoot, and ringing do not affect the measurement.	top – base	On signals not having two major levels (such as triangle or saw-tooth waves), returns same value as pkpk.															
Area	Integral of data: Computes area of waveform between cursors relative to zero level. Values greater than zero contribute positively to the area; values less than zero negatively.	Sum from first to last of data multiplied by horizontal time between points																
Base	Lower of two most probable states (higher is top). Measures lower level in two-level signals. Differs from min in that noise, overshoot, undershoot, and ringing do not affect measurement.	Value of most probable lower state	On signals not having two major levels (triangle or saw-tooth waves, for example), returns same value as min.															
Delay	Time from trigger to transition: Measures time between trigger and first 50% crossing after left cursor. Can measure propagation delay between two signals by triggering on one and determining delay of other.	Time between trigger and first 50% crossing after left cursor																
Duty cycle	Duty cycle: Width as percentage of period.	width/period																
Fall time	<p>Fall time: Duration of falling edge from 90-10%.</p> <table border="1"> <thead> <tr> <th>Thresh.</th> <th>Remote</th> <th>Lower Limit</th> <th>Upper Limit</th> <th>Default</th> </tr> </thead> <tbody> <tr> <td>Lower</td> <td>Low</td> <td>1%</td> <td>45%</td> <td>10%</td> </tr> <tr> <td>Upper</td> <td>High</td> <td>55%</td> <td>99%</td> <td>90%</td> </tr> </tbody> </table> <p>Threshold arguments specify two vertical values on each edge used to compute fall time. Formulas for upper and lower values: lower = lower thresh. x amp/100 + base upper = upper thresh. x amp/100 + base</p>	Thresh.	Remote	Lower Limit	Upper Limit	Default	Lower	Low	1%	45%	10%	Upper	High	55%	99%	90%	<p>Time at upper threshold minus Time at lower threshold averaged over each falling edge</p>	On signals not having two major levels (triangle or saw-tooth waves, for example), top and base can default to maximum and minimum, giving, however, less predictable results.
Thresh.	Remote	Lower Limit	Upper Limit	Default														
Lower	Low	1%	45%	10%														
Upper	High	55%	99%	90%														
Fall 80-20%	Fall 80-20%: Duration of pulse waveform's falling transition from 80% to 20%, averaged for all falling transitions between the cursors.	Average duration of falling 80-20% transition	On signals not having two major levels (triangle or saw-tooth waves, for example), top and base can default to maximum and minimum, giving, however, less predictable results.															
Frequency	Frequency: Period of cyclic signal measured as time between every other pair of 50% crossings. Starting with first transition after left cursor, the period is measured for each transition pair. Values then averaged and reciprocal used to give frequency.	1/period																
Maximum	Measures highest point in waveform. Unlike top, does not assume waveform has two levels.	Highest value in waveform between cursors	Gives similar result when applied to time domain waveform or histogram of data of same waveform. But with histograms, result may include contributions from more than one acquisition. Computes horizontal axis location of rightmost non-zero bin of histogram -- not to be confused with maxp.															
	Average of data for time domain waveform.		Gives similar result when applied to time domain waveform or histogram of data of															

Mean	Computed as centroid of distribution for a histogram.	Average of data	same waveform. But with histograms, result may include contributions from more than one acquisition.															
Minimum	Measures the lowest point in a waveform. Unlike base, does not assume waveform has two levels.	Lowest value in waveform between cursors	Gives similar result when applied to time domain waveform or histogram of data of same waveform. But with histograms, result may include contributions from more than one acquisition.															
Overshoot-	Overshoot negative: Amount of overshoot following a falling edge, as percentage of amplitude.	(base – min.)/ampl x 100	Waveform must contain at least one falling edge. On signals not having two major levels (triangle or saw-tooth waves, for example), may not give predictable results.															
Overshoot+	Overshoot positive: Amount of overshoot following a rising edge specified as percentage of amplitude.	(max. – top)/ampl x 100	Waveform must contain at least one rising edge. On signals not having two major levels (triangle or saw-tooth waves, for example), may not give predictable results.															
Peak to peak	Peak-to-peak: Difference between highest and lowest points in waveform. Unlike ampl, does not assume the waveform has two levels.	maximum – minimum	Gives a similar result when applied to time domain waveform or histogram of data of the same waveform. But with histograms, result may include contributions from more than one acquisition.															
Period	Period of a cyclic signal measured as time between every other pair of 50% crossings. Starting with first transition after left cursor, period is measured for each transition pair, with values averaged to give final result.	$\frac{1}{M_r} \sum_{i=1}^{M_r} (T_{r_i}^{50} - T_{r_i}^{50})$	Where: M_r is the number of leading edges found, M_f the number of trailing edges found, $T_{r_i}^{x\%}$ the time when rising edge i crosses the $x\%$ level, and $T_{f_i}^{x\%}$ the time when falling edge i crosses the $x\%$ level.															
Rise	Rise time: Duration of rising edge from 10-90%. <table border="1" data-bbox="277 1003 618 1108"> <thead> <tr> <th>Thresh.</th> <th>Remote</th> <th>Lower Limit</th> <th>Upper Limit</th> <th>Default</th> </tr> </thead> <tbody> <tr> <td>Lower</td> <td>Low</td> <td>1%</td> <td>45%</td> <td>10%</td> </tr> <tr> <td>Upper</td> <td>High</td> <td>55%</td> <td>99%</td> <td>90%</td> </tr> </tbody> </table> <p>Threshold arguments specify two vertical values on each edge used to compute rise time. Formulas for upper and lower values: lower = lower thresh. x amp/100 + base upper = upper thresh. x amp/100 + base</p>	Thresh.	Remote	Lower Limit	Upper Limit	Default	Lower	Low	1%	45%	10%	Upper	High	55%	99%	90%	Time at lower threshold minus Time at upper threshold averaged over each rising edge	On signals not having two major levels (triangle or saw-tooth waves, for example), top and base can default to maximum and minimum, giving, however, less predictable results.
Thresh.	Remote	Lower Limit	Upper Limit	Default														
Lower	Low	1%	45%	10%														
Upper	High	55%	99%	90%														
Rise 20-80%	Rise 20% to 80%: Duration of pulse waveform's rising transition from 20% to 80%, averaged for all rising transitions between the cursors.	Average duration of rising 20-80% transition	On signals not having two major levels (triangle or saw-tooth waves, for example), top and base can default to maximum and minimum, giving, however, less predictable results.															
RMS	Root Mean Square of data between the cursors -- about same as sdev for a zero-mean waveform.	$\sqrt{\frac{1}{N} \sum_{i=1}^N (v_i)^2}$	Gives similar result when applied to time domain waveform or histogram of data of same waveform. But with histograms, result may include contributions from more than one acquisition. Where: v_i denotes measured sample values, and N = number of data points within the periods found up to maximum of 100 periods.															
Skew	Time of clock1 edge minus time of nearest clock2 edge.		Reference levels and edge-transition polarity can be selected. Hysteresis argument used to discriminate levels from noise in data. Hysteresis on a measurement (if set to 500 mdiv) requires that the signal must transition one way 1/2 division (total swing) across the threshold for the measurement to be valid. Available with JTA2 and XMAP options.															

Std dev	Standard deviation of the data between the cursors -- about the same as rms for a zero-mean waveform.	$\sqrt{\frac{1}{N} \sum_{i=1}^N (v_i - \text{mean})^2}$	Gives similar result when applied to time domain waveform or histogram of data of same waveform. But with histograms, result may include contributions from more than one acquisition. Where: v_i denotes measured sample values, and N = number of data points within the periods found up to maximum of 100 periods.
Top	Higher of two most probable states, the lower being base; it is characteristic of rectangular waveforms and represents the higher most probable state determined from the statistical distribution of data point values in the waveform.	Value of most probable higher state	Gives similar result when applied to time domain waveform or histogram of data of same waveform. But with histograms, result may include contributions from more than one acquisition.
WidthN	Width measured at the 50% level and negative slope.		
Width	Width of cyclic signal determined by examining 50% crossings in data input. If first transition after left cursor is a rising edge, waveform is considered to consist of positive pulses and width the time between adjacent rising and falling edges. Conversely, if falling edge, pulses are considered negative and width the time between adjacent falling and rising edges. For both cases, widths of all waveform pulses are averaged for the final result.	Width of first positive or negative pulse averaged for all similar pulses	

[Top of Page](#)

INTRODUCTION TO MATH TRACES AND FUNCTIONS

With the instrument's math tools you can perform mathematical functions on a waveform displayed on any channel, or recalled from any of the four reference memories M1 to M4. You can also chain dual math functions: $f(g(x))$.

Two-input Math Functions

Arithmetic operators (+, -, x, /) require two source inputs. These inputs can be channel traces, zooms, or memory traces. You can use a channel input with a math or memory trace, but you cannot use a zoom trace with a channel, memory, or math trace for these operations. That is, a zoom trace can only operate on another zoom trace.

Chaining of Math Functions

This is an optional feature with the MathSurfer package.

1. Push the **MATH** front panel button to display the Math setup dialog.



2. Touch the **Dual** (function of a function) button if the FFT is to be of the result of another math operation.
3. Touch inside the **Source1** field and select a source trace from the pop-up menu.
4. Touch inside the **Operator1** field and select a math function from the pop-up menu.
5. Touch inside the **Operator2** field and select a math function from the pop-up menu.

Zooming a Math Function

You can easily zoom a math function as follows:

1. Touch the **Math** trace *label* to open the Math setup dialog.
2. Touch the **Zoom** *button* at the bottom of the screen.
3. To turn off zoom and restore the math trace, touch the **Reset Zoom** button in the Zoom *mini-dialog*.

[Top of Page](#)

WHY USE FFT?

For a large class of signals, you can gain greater insight by looking at spectral representation rather than time description. Signals encountered in the frequency response of amplifiers, oscillator phase noise and those in mechanical vibration analysis, for example, are easier to observe in the frequency domain.

If sampling is done at a rate fast enough to faithfully approximate the original waveform (usually five times the highest frequency component in the signal), the resulting discrete data series will uniquely describe the analog signal. This is of particular value when dealing with transient signals because, unlike FFT, conventional swept spectrum analyzers cannot handle them.

Spectral analysis theory assumes that the signal for transformation is of infinite duration. Since no physical signal can meet this condition, a useful assumption for reconciling theory and practice is to view the signal as consisting of an infinite series of replicas of itself. These replicas are multiplied by a rectangular window (the display grid) that is zero outside of the observation grid.

An FFT operation on an N-point time domain signal can be compared to passing the signal through a comb filter consisting of a bank of N/2 filters. All the filters have the same shape and width and are centered at N/2 discrete frequencies. Each filter collects the signal energy that falls into the immediate neighborhood of its center frequency. Thus it can be said that there are N/2 frequency bins. The distance in Hz between the center frequencies of two neighboring bins is always the same: Δf .

Power (Density) Spectrum

Because of the linear scale used to show magnitudes, lower amplitude components are often hidden by larger components. In addition to the functions offering magnitude and phase representations, the FFT option offers power density and power spectrum density functions. These latter functions are even better suited for characterizing spectra. The power spectrum (V^2) is the square of the magnitude spectrum (0 dBm corresponds to voltage equivalent to 1 mW into 50 ohms.) This is the representation of choice for signals containing isolated peaks — periodic signals, for instance.

The power density spectrum (V^2/Hz) is the power spectrum divided by the equivalent noise bandwidth of the filter associated with the FFT calculation. This is best employed for characterizing broadband signals such as noise.

Memory for FFT

The amount of acquisition memory available will determine the maximum range (Nyquist frequency) over which signal components can be observed. Consider the problem of determining the length of the observation window and the size of the acquisition buffer if a Nyquist rate of 500 MHz and a resolution of 10 kHz are required. To obtain a resolution of 10 kHz, the acquisition time must be at least:

$$T = 1/\Delta f = 1/10 \text{ kHz} = 100 \text{ ms}$$

For a digital oscilloscope with a memory of 100 kB, the highest frequency that can be analyzed is:

$$\Delta f \times N/2 = 10 \text{ kHz} \times 100 \text{ kB}/2 = 500 \text{ MHz}$$

FFT Pitfalls to Avoid

Take care to ensure that signals are correctly acquired: improper waveform positioning within the observation window produces a distorted spectrum. The most common distortions can be traced to insufficient sampling, edge discontinuities, windowing or the "picket fence" effect.

Because the FFT acts like a bank of band-pass filters centered at multiples of the frequency resolution, components that are not exact multiples of that frequency will fall within two consecutive filters. This results in an attenuation of the true amplitude of these components.

Picket Fence and Scallop

The highest point in the spectrum can be 3.92 dB lower when the source frequency is halfway between two discrete frequencies. This variation in spectrum magnitude is the picket fence effect. The corresponding attenuation loss is referred to as scallop loss. LeCroy scopes automatically correct for the scallop effect, ensuring that the magnitude of the spectra lines correspond to their true values in the time domain.

If a signal contains a frequency component above Nyquist, the spectrum will be aliased, meaning that the frequencies will be folded back and spurious. Spotting aliased frequencies is often difficult, as the aliases may ride on top of real harmonics. A simple way of checking is to modify the sample rate and observe whether the frequency distribution changes.

Leakage

FFT assumes that the signal contained within the time grid is replicated endlessly outside the observation window. Therefore

if the signal contains discontinuities at its edges, pseudo-frequencies will appear in the spectral domain, distorting the real spectrum. When the start and end phase of the signal differ, the signal frequency falls within two frequency cells, broadening the spectrum.

The broadening of the base, stretching out in many neighboring bins, is termed leakage. Cures for this are to ensure that an integral number of periods is contained within the display grid or that no discontinuities appear at the edges. Another is to use a window function to smooth the edges of the signal.

Choosing a Window

The choice of a spectral window is dictated by the signal’s characteristics. Weighting functions control the filter response shape, and affect noise bandwidth as well as side lobe levels. Ideally, the main lobe should be as narrow and flat as possible to effectively discriminate all spectral components, while all side lobes should be infinitely attenuated. The window type defines the bandwidth and shape of the equivalent filter to be used in the FFT processing.

In the same way as one would choose a particular camera lens for taking a picture, some experimenting is generally necessary to determine which window is most suitable. However, the following general guidelines should help.

Rectangular windows provide the highest frequency resolution and are thus useful for estimating the type of harmonics present in the signal. Because the rectangular window decays as a $(\sin x)/x$ function in the spectral domain, slight attenuation will be induced. Alternative functions with less attenuation (Flat Top and Blackman-Harris) provide maximum amplitude at the expense of frequency resolution. Whereas, Hamming and Von Hann are good for general purpose use with continuous waveforms.

Window Type	Applications and Limitations
Rectangular	These are normally used when the signal is transient (completely contained in the time-domain window) or known to have a fundamental frequency component that is an integer multiple of the fundamental frequency of the window. Signals other than these types will show varying amounts of spectral leakage and scallop loss, which can be corrected by selecting another type of window.
Hanning (Von Hann)	These reduce leakage and improve amplitude accuracy. However, frequency resolution is also reduced.
Hamming	These reduce leakage and improve amplitude accuracy. However, frequency resolution is also reduced.
Flat Top	This window provides excellent amplitude accuracy with moderate reduction of leakage, but with reduced frequency resolution.
Blackman-Harris	It reduces the leakage to a minimum, but with reduced frequency resolution.

FFT Window Filter Parameters				
Window Type	Highest Side Lobe (dB)	Scallop Loss (dB)	ENBW (bins)	Coherent Gain (dB)
Rectangular	-13	3.92	1.0	0.0
von Hann	-32	1.42	1.5	-6.02
Hamming	-43	1.78	1.37	-5.35
Flat Top	-44	0.01	2.96	-11.05
Blackman-Harris	-67	1.13	1.71	-7.53

Improving Dynamic Range

[Enhanced resolution](#) uses a low-pass filtering technique that can potentially provide for three additional bits (18 dB) if the signal noise is uniformly distributed (white). Low-pass filtering should be considered when high frequency components are irrelevant. A distinct advantage of this technique is that it works for both repetitive and transient signals. The SNR increase is conditioned by the cut-off frequency of the ERES low-pass filter and the noise shape (frequency distribution).

LeCroy digital oscilloscopes employ FIR digital filters so that a constant phase shift is maintained. The phase information is therefore not distorted by the filtering action.

Record Length

Because of its versatility, FFT analysis has become a popular analysis tool. However, some care must be taken with it. In most instances, incorrect positioning of the signal within the display grid will significantly alter the spectrum. Effects such as leakage and aliasing that distort the spectrum must be understood if meaningful conclusions are to be arrived at when using FFT.

An effective way to reduce these effects is to maximize the acquisition record length. Record length directly conditions the effective sampling rate of the scope and therefore determines the frequency resolution and span at which spectral analysis can be carried out.

[Top of Page](#)

FFT ALGORITHMS

A summary of the algorithms used in the oscilloscope's FFT computation is given here in a few steps:

1. The data are multiplied by the selected window function.
2. FFT is computed, using a fast implementation of the DFT (Discrete Fourier Transform):

$$X_n = \frac{1}{N} \sum_{k=0}^{N-1} x_k \times W^{nk}$$

where: x_k is a complex array whose real part is the modified source time domain waveform, and whose imaginary part is 0; X_n is the resulting complex frequency-domain waveform; $W = e^{-2\pi j/N}$; and N is the number of points in x_k and X_n .

The generalized FFT algorithm, as implemented here, works on N , which need *not* be a power of 2.

3. The resulting complex vector X_n is divided by the coherent gain of the window function, in order to compensate for the loss of the signal energy due to windowing. This compensation provides accurate amplitude values for isolated spectrum peaks.
4. The real part of X_n is symmetric around the Nyquist frequency, that is

$$R_n = R_{N-n}$$

while the imaginary part is asymmetric, that is

$$I_n = -I_{N-n}$$

The energy of the signal at a frequency n is distributed equally between the first and the second halves of the spectrum; the energy at frequency 0 is completely contained in the 0 term.

The first half of the spectrum (Re, Im), from 0 to the Nyquist frequency is kept for further processing and doubled in amplitude:

$$R'_n = 2 \times R_n \quad 0 \leq n < N/2$$

$$I'_n = 2 \times I_n \quad 0 \leq n < N/2$$

5. The resultant waveform is computed for the spectrum type selected.

If "Magnitude" is selected, the magnitude of the complex vector is computed as:

$$M_n = \sqrt{R_n^2 + I_n^2}$$

Steps 1–5 lead to the following result:

An AC sine wave of amplitude 1.0 V with an integral number of periods N_p in the time window, transformed with the rectangular window, results in a fundamental peak of 1.0 V magnitude in the spectrum at frequency $N_p \times \Delta f$. However, a DC component of 1.0 V, transformed with the rectangular window, results in a peak of 2.0 V magnitude at 0 Hz.

The waveforms for the other available spectrum types are computed as follows:

$$\text{Phase: angle} = \arctan(I_n/R_n) \quad M_n > M_{min}$$

$$\text{angle} = 0 \quad M_n \leq M_{min}$$

Where M_{min} is the minimum magnitude, fixed at about 0.001 of the full scale at any gain setting, below which the angle is not well defined.

The dBm Power Spectrum:

$$\text{dBm PS} = 10 \times \log_{10} \left(\frac{M_n^2}{M_{ref}^2} \right) = 20 \times \log_{10} \left(\frac{M_n}{M_{ref}} \right)$$

where $M_{ref} = 0.316$ V (that is, 0 dBm is defined as a sine wave of 0.316 V peak or 0.224 V rms, giving 1.0 mW into 50 ohms).

The dBm Power Spectrum is the same as dBm Magnitude, as suggested in the above formula.

dBm Power Density:

$$dBmPD = dBmPS - 10 \times \log_{10} (ENBW \times \Delta f)$$

where *ENBW* is the equivalent noise bandwidth of the filter corresponding to the selected window, and *Delta f* is the current frequency resolution (bin width).

7. The FFT Power Average takes the complex frequency-domain data R'_n and I'_n for each spectrum generated in Step 5, and computes the square of the magnitude:

$$M_n^2 = R_n'^2 + I_n'^2,$$

then sums M_n^2 and counts the accumulated spectra. The total is normalized by the number of spectra and converted to the selected result type using the same formulas as are used for the Fourier Transform.

[Top of Page](#)

GLOSSARY

This section defines the terms frequently used in FFT spectrum analysis and relates them to the oscilloscope.

Aliasing If the input signal to a sampling acquisition system contains components whose frequency is greater than the Nyquist frequency (half the sampling frequency), there will be less than two samples per signal period. The result is that the contribution of these components to the sampled waveform is indistinguishable from that of components below the Nyquist frequency. This is **aliasing**.

The timebase and transform size should be selected so that the resulting Nyquist frequency is higher than the highest significant component in the time-domain record.

Coherent Gain The normalized coherent gain of a filter corresponding to each window function is 1.0 (0 dB) for a rectangular window and less than 1.0 for other windows. It defines the loss of signal energy due to the multiplication by the window function. This loss is compensated for in the oscilloscope. The following table lists the values for the implemented windows.

Window Frequency Domain Parameters				
Window Type	Highest Side Lobe (dB)	Scallop Loss (dB)	ENBW (bins)	Coherent Gain (dB)
Rectangular	-13	3.92	1.0	0.0
Hanning (Von Hann)	-32	1.42	1.5	-6.02
Hamming	-43	1.78	1.37	-5.35
Flattop	-44	0.01	2.96	-11.05
Blackman-Harris	-67	1.13	1.71	-7.53

ENBW Equivalent Noise BandWidth (ENBW) is the bandwidth of a rectangular filter (same gain at the center frequency), equivalent to a filter associated with each frequency bin, which would collect the same power from a white noise signal. In the table on the previous page, the ENBW is listed for each window function implemented, given in bins.

Filters Computing an N-point FFT is equivalent to passing the time-domain input signal through N/2 filters and plotting their outputs against the frequency. The spacing of filters is $\Delta f = 1/T$, while the bandwidth depends on the window function used (see [Frequency Bins](#)).

Frequency Bins The FFT algorithm takes a discrete source waveform, defined over N points, and computes N complex Fourier coefficients, which are interpreted as harmonic components of the input signal.

For a real source waveform (imaginary part equals 0), there are only N/2 independent harmonic components.

An FFT corresponds to analyzing the input signal with a bank of N/2 filters, all having the same shape and width, and centered at N/2 discrete frequencies. Each filter collects the signal energy that falls into the immediate neighborhood of its center frequency. Thus it can be said that there are N/2 "frequency bins."

The distance in hertz between the center frequencies of two neighboring bins is always:

$$\Delta f = 1/T$$

where T is the duration of the time-domain record in seconds.

The width of the main lobe of the filter centered at each bin depends on the window function used. The rectangular window has a nominal width at 1.0 bin. Other windows have wider main lobes (see [table](#)).

Frequency Range The range of frequencies computed and displayed is 0 Hz (displayed at the left-hand edge of the screen) to the Nyquist frequency (at the rightmost edge of the trace).

Frequency Resolution In a simple sense, the frequency resolution is equal to the bin width Δf . That is, if the input signal changes its frequency by Δf , the corresponding spectrum peak will be displaced by Δf . For smaller changes of frequency, only the shape of the peak will change.

However, the effective frequency resolution (that is, the ability to resolve two signals whose frequencies are almost the same) is further limited by the use of window functions. The ENBW value of all windows other than the rectangular is greater than Δf and the bin width. The table of [Window Frequency-Domain Parameters](#) lists the ENBW values for the implemented windows.

Leakage In the power spectrum of a sine wave with an integral number of periods in the (rectangular) time window (that is, the source frequency equals one of the bin frequencies), the spectrum contains a sharp component whose value accurately reflects the source waveform's amplitude. For intermediate input frequencies this spectral component has a lower and broader peak.

The broadening of the base of the peak, stretching out into many neighboring bins, is termed *leakage*. It is due to the relatively high side lobes of the filter associated with each frequency bin.

The filter side lobes and the resulting leakage are reduced when one of the available window functions is applied. The best reduction is provided by the Blackman–Harris and Flattop windows. However, this reduction is offset by a broadening of the main lobe of the filter.

Number of Points The FFT is computed over the number of points (Transform Size) whose upper bounds are the source number of points, and by the maximum number of points selected in the menu. The FFT generates spectra of N/2 output points.

Nyquist Frequency The Nyquist frequency is equal to one half of the effective sampling frequency (after the decimation): $\Delta f \times N/2$.

Picket Fence Effect If a sine wave has a whole number of periods in the time domain record, the power spectrum obtained with a rectangular window will have a sharp peak, corresponding exactly to the frequency and amplitude of the sine wave. Otherwise the spectrum peak with a rectangular window will be lower and broader.

The highest point in the power spectrum can be 3.92 dB lower (1.57 times) when the source frequency is halfway between two discrete bin frequencies. This variation of the spectrum magnitude is called the *picket fence effect* (the loss is called the scallop loss).

All window functions compensate for this loss to some extent, but the best compensation is obtained with the Flattop window.

Power Spectrum The power spectrum (V^2) is the square of the magnitude spectrum.

The power spectrum is displayed on the dBm scale, with 0 dBm corresponding to:

$$V_{\text{ref}}^2 = (0.316 V_{\text{peak}})^2,$$

where V_{ref} is the peak value of the sinusoidal voltage, which is equivalent to 1 mW into 50 ohms.

Power Density Spectrum The power density spectrum (V^2/Hz) is the power spectrum divided by the equivalent noise bandwidth of the filter, in hertz. The power density spectrum is displayed on the dBm scale, with 0 dBm corresponding to ($V_{\text{ref}}^2/\text{Hz}$).

Sampling Frequency The time-domain records are acquired at sampling frequencies dependent on the selected time base. Before the FFT computation, the time-domain record may be decimated. If the selected maximum number of points is lower than the source number of points, the effective sampling frequency is reduced. The effective sampling frequency equals twice the Nyquist frequency.

Scallop Loss This is loss associated with the picket fence effect.

Window Functions All available window functions belong to the sum of cosines family with one to three non-zero cosine terms:

$$W_k = \sum_{m=0}^{M-1} a_m \cos\left(\frac{2\pi k m}{N}\right) \quad 0 \leq k < N$$

where: $M = 3$ is the maximum number of terms, a_m are the coefficients of the terms, N is the number of points of the decimated source waveform, and k is the time index.

The table of [Coefficients of Window Functions](#) lists the coefficients a_m . The window functions seen in the time domain are symmetric around the point $k = N/2$.

Coefficients of Window Functions			
Window Type	a_0	a_1	a_2
Rectangular	1.0	0.0	0.0
Hanning (Von Hann)	0.5	-0.5	0.0
Hamming	0.54	-0.46	0.0
Flattop	0.281	-0.521	0.198
Blackman–Harris	0.423	-0.497	0.079

FFT SETUP

To Set Up an FFT

1. In the menu bar touch **Math**, then **Math Setup...** in the drop-down menu.
2. Touch inside the **Operator1** field and select **FFT**  from the menu.
3. Touch inside the **Source1** field and select a channel, memory, or zoom trace on which to perform the FFT.
4. Touch inside the **Operator1** field and select **FFT** from the pop-up menu.
5. In the right-hand dialog, touch the **FFT** tab.
6. Touch the **Suppress DC** checkbox if you want to make the DC bin go to zero. Otherwise, leave it unchecked.
7. Touch inside the **Window** field, select a window type.

[Top of Page](#)

PASS/FAIL TESTING

[Mask Tests](#)

[Actions](#)

[Setting Up Pass/Fail Testing](#)



Mask Tests

[Setting Up Mask Tests](#)

You have the choice to do mask testing by using an existing mask, or by using a mask created from your actual waveform, with vertical and horizontal tolerances that you define. Existing masks can be loaded from a floppy disk or from a network.

You can set your mask test to be True for waveforms All In, All Out, Any In, or Any Out. For example, if you select All In, the test will be False if even a single waveform falls outside the mask.

Masks that you create from your waveform can be confined to just a portion of the trace by use of a measure gate. (See [Measure Gate](#) for an explanation of how this feature works.)

Actions

[Setting Up Pass/Fail Actions](#)

You can decide the actions to occur upon your waveforms' passing or failing, by selecting one or all of the following:

- stop
- audible alarm
- print image of display
- emit pulse
- save waveform

The selection **Pulse** causes a pulse to be output through the Aux Out connector at the front of the scope. This pulse can be used to trigger another scope. You can set the amplitude and width of the pulse as described in [Auxiliary Output Signals](#).

Setting Up Pass/Fail Testing

Initial Setup

1. Touch **Analysis** in the menu bar, then **Pass/Fail Setup...** in the drop-down menu.
2. Touch the **Actions** tab.



3. Touch either the **Pass** or **Fail** button to set the actions to occur upon your waveform's passing or failing the test.
4. Touch the actions you want to occur: stop test, sound alarm, print result, emit pulse, or save the waveform. If you want to have the results printed and your scope is not equipped with a printer, be sure that it is connected to a local or network printer. See [Printing](#).
5. If you want to save your waveform automatically, touch the **Save Setup**. This will take you out of the current dialog and will open the "Save Waveform" dialog. See [Saving and Recalling Waveforms](#).

Mask Testing

1. Touch **Analysis** in the menu bar, then **Pass/Fail Setup...** in the drop-down menu.
2. Touch inside the **Source1** field and select a source from the pop-up menu.
3. From the "Test" mini-dialog, make a selection in the **Test is True when group of buttons**. This selection means, for example, that if you select **All Out** the test will be False if even a single waveform falls inside the mask.
4. From **Show Markers**, choose whether or not to have mask violations displayed.
5. If you are loading a pre-existing mask, touch the **Load Mask** tab, then the **File** button. You can then enter the file name or browse to its location.
6. If you want to make a mask from your waveform, touch the **Make Mask** tab.
7. Touch inside the **Ver Delta** and **Hor Delta** fields and enter boundary values, using the pop-up numeric keypad.
8. Touch the **Browse** button to create a file name and location for the mask if you want to save it.
9. Touch the **Make From Trace** button to use your currently displayed trace as a source for the mask.
10. Touch the **Gate** tab, then enter values in the **Start** and **Stop** fields to constrain the mask to a portion of the waveform. Or, you can simply touch and drag the Gate posts, which initially are placed at the extreme left and right ends of the grid.

[Top of Page](#)

STATUS

The status read-only dialog displays system information including serial number, firmware version, and installed software and hardware options.

To Access Status Dialog

1. In the menu bar, touch **Utilities**.
2. Touch the **Status** tab.

REMOTE COMMUNICATION

The Remote dialog is where you can select a network communication protocol, establish network connections, and configure the Remote Control Assistant log. The choice of communication protocols is limited to TCPIP and GPIB.

Note: GPIB is an option and requires a GPIB card to be installed in a card slot at the rear of the scope.

Note: The instrument uses Dynamic Host Configuration Protocol (DHCP) as its addressing protocol. Therefore, it is not necessary to set up an IP address if your network supports DHCP. If it does not, you can assign a static address in the standard Windows 2000 network setup menu.

The Remote Control Assistant monitors communication between your PC and scope when you are operating the instrument remotely. You can log all events, or errors only. This log can be invaluable when you are creating and debugging remote control applications.

To Set Up Remote Communication.

If you are connecting the scope to a network, first contact your Information Systems administrator. If you are connecting the scope directly to your PC, connect a GPIB or Ethernet cable between them.

1. In the menu bar touch **Utilities**, then **Utilities Setup...** in the drop-down menu.
2. Touch the **Remote** tab.
3. Make a **Port** selection: **TCPIP** (transmission control protocol/Internet protocol) or **GPIB** (general purpose interface bus). If you do not have a GPIB card installed, the GPIB selection will not be accessible.
4. If you are using GPIB, set a GPIB address by touching inside the **GPIB Address** data entry field and enter an address.
5. Press the **Net Connections** button; the Windows **Network and Dial-up Connections** window appears.
6. Touch **Make New Connection** and use the Windows Network Connection Wizard to make a new connection; or, touch Local Area Connection to reconfigure the scope's connection if it is already connected to the network.

To Configure the Remote Control Assistant Event Log

1. In the menu bar touch **Utilities**, then **Utilities Setup...** in the drop-down menu.
2. Touch the **Remote** tab.
3. Touch inside the **Log Mode** data entry field.
4. Select **Off**, **Errors Only**, or **Full Dialog** from the pop-up menu.
5. To export the contents of the event log to an ASCII text file, touch the **Show Remote Control Log** button: the "Event Logs" popup window appears. Touch inside the **DestFilename** data entry field and enter a file name, using the pop-up keyboard. Then touch the **Export to Text File** button.

[Top of Page](#)

HARDCOPY



Printing

For print setup, refer to [Printing](#).



Clipboard

This selection prints to the clipboard so you can paste a file into another application (like MS Word, for example).

To Print from the Clipboard

1. In the menu bar touch **Utilities**, then **Utilities Setup...** in the drop-down menu.
2. Touch the **Hardcopy** tab.
3. Under **Colors**, touch the **Use Print Colors** checkbox if you want the traces printed on a white background. A white background saves printer toner.
4. Touch the **Grid Area Only** checkbox if you do not need to print the dialog area and you only want to show the waveforms and grids.
5. Touch the **Print Now** button.



File

Choose **File** if you want to output the screen image to storage media such as floppy drive or hard drive. When outputting to floppy disk, be sure to use a preformatted disk.

To Print to File

1. In the menu bar touch **Utilities**, then **Utilities Setup...** in the drop-down menu.
2. Touch the **Hardcopy** tab, then the **File** icon.
3. Touch inside the **File Format** data entry field and select a graphic file format from the pop-up menu.
4. Under **Colors**, touch the **Use Print Colors** checkbox if you want the traces printed on a white background. A white background saves printer toner.
5. Touch inside the **Directory** data entry field and type the path to the folder you want to print to, using the pop-up keyboard. Or touch the **Browse** button and navigate to the folder.
6. Touch inside the **File Name** data entry field and enter a name for the display image, using the pop-up keyboard.
7. Touch the **Grid Area Only** checkbox if you do not need to print the dialog area and you only want to show the waveforms and grids.
8. Touch the **Print Now** button.



E-Mail

The instrument also gives you the option to e-mail your screen images, using either the MAPI or SMTP protocols. Before you output to e-mail from the Utilities dialog, you first have to set up the e-mail server and recipient address in [Preference Setup](#).

To Send E-mail

1. In the menu bar touch **Utilities**, then **Utilities Setup...** in the drop-down menu.
2. Touch the **Hardcopy** tab, then the **E-mail** button.
3. Touch the **Configure E-Mail Server and Recipient** button and enter the recipient's email address. Then return to Utilities -- E-mail.
4. Touch inside the **File Format** data entry field and select a graphic file format from the pop-up menu.
5. Under **Colors**, touch the **Use Print Colors** checkbox if you want the traces printed on a white background. A white background saves printer toner.
6. Touch the **Prompt for message to send with mail** checkbox if you want to include remarks with the image.
7. Touch the **Grid Area Only** checkbox if you do not need to print the dialog area and you only want to show the waveforms and grids.
8. Touch the **Print Now** button.

[Top of Page](#)

AUX OUTPUT

Refer to [Auxiliary Output Signals](#).

DATE & TIME

The instrument gives you the choice of manually setting the time and date or getting it from the Internet. If you elect to get the time and date from the Internet, you need to have the scope connected to the Internet through the LAN connector on the rear panel. You can also set time zones and daylight savings time.

To Set Time and Date Manually

1. In the menu bar touch **Utilities**, then **Utilities Setup...** in the drop-down menu.
2. Touch the **Date/Time** tab.
3. Touch inside each of the **Hour**, **Minute**, **Second**, **Day**, **Month**, and **Year** data entry fields and enter a value, using the pop-up numeric keypad.
4. Touch the **Validate Changes** button.

To Set Time and Date from the Internet

The Simple Network Time Protocol (SNTP) is used.

1. Ensure that the scope is connected to the Internet through the LAN connector at the rear of the scope.
2. In the menu bar touch **Utilities**, then **Utilities Setup...** in the drop-down menu.
3. Touch the **Date/Time** tab.
4. Touch the **Set from Internet** button.

To Set Time and Date from Windows

1. In the menu bar touch **Utilities**, then **Utilities Setup...** in the drop-down menu.
2. Touch the **Date/Time** tab.



3. Touch the **Windows Date/Time** button
4. Use the **Time & Date Properties** *window* to configure the time, including time zone.

[Top of Page](#)

OPTIONS

Use this dialog to add or remove software options. For information about software options, contact your local LeCroy Sales and Service office, or visit our Web site at <http://www.lecroy.com/options>.

Options that you purchase, such as JTA2, add performance to you instrument. This added performance is seen in the new math functions or parameters that you can choose from when doing Measure or Math setups.

PREFERENCES

[Audible Feedback](#)

[Auto-calibration](#)

[Language Selection for User Interface](#)

[Offset Control](#)

[Delay Control](#)

[E-mail](#)

Audible Feedback

You can elect to have audible confirmation each time you touch a screen or front panel control.

1. In the menu bar touch **Utilities**; then touch **Preferences** in the drop-down menu.
2. Touch the "Audible Feedback" **Enable** checkbox so that the scope emits a beep with each touch of the screen or front panel control.

Auto-calibration

You can choose to have your instrument automatically recalibrate itself whenever there is a significant change in ambient temperature. If you do not enable this option, the scope will only recalibrate at startup and whenever you make a change to certain operating conditions.

1. In the menu bar touch **Utilities**; then touch **Preferences** in the drop-down menu.
2. Touch the "Automatic Calibration" **Enable** checkbox.

Language Selection for User Interface

The names of UI buttons, tabs, and fields can be instantly changed to another language.

1. In the menu bar touch **Utilities**; then touch **Preferences** in the drop-down menu.
2. Touch inside the "Language" field and select a language from the pop-up menu.

Offset Control

As you change the gain, this control allows you to either keep the vertical offset level indicator stationary (when **Div** is selected) or to have it move with the actual voltage level (when **Volts** is selected). The advantage of selecting **Div** is that the waveform will remain on the grid as you increase the gain; whereas, if **Volts** is selected, the waveform could move off the grid.

Note: Regardless of whether you select **Volts** or **Div**, the "Offset" shown in the channel setup dialog always indicates volts. However, when **Div** is selected for the Offset Control, the offset in volts is scaled proportional to the change in gain, thereby keeping the division on the grid constant.

1. In the menu bar touch **Utilities**; then touch **Preferences** in the drop-down menu.
2. Touch the **Offset/Delay** tab.
3. Under **Offset Setting constant in:**, touch either the **Div** or **Volts** button.

Delay Control

As you change the timebase, this control allows you to either keep the horizontal offset indicator stationary (when **Div** is selected) or to have it move with the trigger point (when **Time** is selected). The advantage of selecting **Div** is that the trigger point will remain on the grid as you increase the timebase; whereas, if **Time** is selected, the trigger point could move off the grid.

Note: Regardless of whether you select **Time** or **Div**, the "Delay" shown in the timebase setup dialog always indicates time. However, when **Div** is selected for Delay In, the delay in time is scaled proportional to the change in timebase, thereby keeping the division on the grid constant.

1. In the menu bar touch **Utilities**; then touch **Preferences** in the drop-down menu.
2. Touch the **Offset/Delay** tab.
3. Under **Delay Setting constant in:**, touch either the **Div** or **Volts** button.

E-mail

Before you can send e-mail from the scope, it must first be configured.

1. In the menu bar touch **Utilities**, then **Preference Setup...** in the drop-down menu.
2. Touch the **E-mail** tab.
3. Choose an e-mail server protocol:
MAPI (Messaging Application Programming Interface) is the Microsoft interface specification that allows different messaging and workgroup applications (including e-mail, voice mail, and fax) to work through a single client, such as the Exchange client included with Windows 95 and Windows NT. MAPI uses the default Windows e-mail application (usually Outlook Express).

SMTP (Simple Mail Transfer Protocol) is a TCP/IP protocol for sending messages from one computer to another through a network. This protocol is used on the Internet to route e-mail. In many cases no account is needed.

4. If you chose MAPI, touch inside the **Originator Address (From:)** data entry field and use the pop-up keyboard to type in the instrument's e-mail address. Then touch inside the **Default Recipient Address (To:)** data entry field and use the pop-up keyboard to enter the recipient's e-mail address.
5. If you chose SMTP, touch inside the **SMTP Server** data entry field and use the pop-up keyboard to enter the name of your server. Touch inside the **Originator Address (From:)** data entry field and use the pop-up keyboard to type in the instrument's e-mail address. Then touch inside the **Default Recipient Address (To:)** data entry field and use the pop-up keyboard to enter the recipient's e-mail address.
6. You can send a test e-mail text message by touching the **Send Test Mail** button. The test message reads "Test mail from [name of scope's email address]."

Now that you have configured your email, go to Utilities -- Hardcopy -- [Email](#) to tell the scope how to send your images: in what file format, how much background info, color of background.

[Top of Page](#)

ACQUISITION STATUS

For each general category of scope operation, you can view a summary of your setups. These dialogs are accessed from the menu bar drop-down menus. The categories are as follows:

- Vertical -- select **Channels Status . . .** from the drop-down menu
- Timebase -- select **Acquisition Status . . .** from the drop-down menu
- Trigger -- select **Acquisition Status . . .** from the drop-down menu
- Math -- select **Math Status . . . Zoom Status . . . or Memory Status** from the drop-down menu

In addition to these dialogs, summaries are also provided for XY setups, memory (M1-M4) setups, and time stamps for sequence mode sampling.

[Top of Page](#)

SERVICE



This button provides access to service dialogs, which are for the sole use of LeCroy service personnel. A security code is required to gain access.

SHOW WINDOWS DESKTOP



Touching the **Show Windows Desktop** button in the main "Utilities" dialog minimizes the instrument application to reveal the underlying desktop. To maximize the application, touch the appropriate [shortcut icon](#).

TOUCH SCREEN CALIBRATION



Touching the **Touch-Screen Calibration** button starts the calibration procedure. During the procedure, you will be prompted to touch the center of a small cross in 5 key locations on the touch screen. Because sufficient accuracy cannot be achieved using your finger, use a stylus instead for this procedure. The calibration has a ten-second timeout in case no cross is touched.

To avoid parallax errors, be sure to place your line of sight directly in front of each cross before touching it.